



User Guide

Optima XPN Series

Preparative Ultracentrifuges



PN B08115AL
March 2023



Beckman Coulter, Inc.
250 S. Kraemer Blvd.
Brea, CA 92821 U.S.A.



Optima XPN Series Preparative Ultracentrifuges User Guide

PN B08115AL (March 2023)

© 2023 Beckman Coulter, Inc.
All rights reserved

Trademarks

Beckman Coulter, the stylized logo, and the Beckman Coulter product and service marks mentioned herein are trademarks or registered trademarks of Beckman Coulter, Inc. in the United States and other countries.

All other trademarks, service marks, products, or services are trademarks or registered trademarks of their respective holders.

Contact Us

If you have any questions, contact our Customer Support Center.

- Worldwide, find us via our website at www.beckman.com/support/technical.
- In Austria, call us at 0810 300484
- In Germany, call us at 02151 333999
- In Sweden, call us at +46 (0)8 564 859 14
- In the Netherlands, call us at +31 348 799 815
- In France, call us at 0825838306 6
- In the UK, call us at +44 845 600 1345
- In Ireland, call us at +353 (01) 4073082
- In Italy, call us at +39 0295392 456
- In other locales, contact your local Beckman Coulter Representative.

EC REP

Beckman Coulter Eurocenter S.A.
22, rue Juste-Olivier
Case Postale 1044
CH - 1260 Nyon 1, Switzerland
Tel: +41 (0) 22 365 36 11

Glossary of Symbols is available at
beckman.com/techdocs (PN C24689).

*May be covered by one or more pat. - see
www.beckman.com/patents*

Original Instructions

Revision History

B08115AA, Initial Issue, 09/2011

Issue Version AB, 01/2014

Manual updated per Canadian Standards Association (CSA) guidelines.

Issue Version AC, 01/2015

Changes or additions were made to: Getting Access to the Sample; Restoring the Instrument to Operating Condition.

Issue Version AD, 04/2016

Changes or additions were made to: Multiple Compliance

Issue Version AE, 09/2016

Changes or additions were made to:

- Chemical and Biological Safety
- CHAPTER 2, System References
- CHAPTER 8, References Page

Issue Version AF, 02/2018

Changes or additions were made to: Table C.1, Diagnostics/User Messages Chart.

Issue Version AG, 08/2019

Changes or additions were made to: Figure 2.23, About Page; CHAPTER 3, Manual Operation; Figure 3.2, Zonal Operation Page with Cancel Button; Figure 3.10, Zonal Page; Figure 3.11, Continuous Flow Page; CHAPTER 3, Loading the Sample; CHAPTER 3, Running the Sample; CHAPTER 3, Unloading the Sample; CHAPTER 8, Select Rotor and Labware Page (Library); CHAPTER 8, Select Rotor and Labware Page (Catalog); CHAPTER 8, Compatible Tubes for Rotor Page; CHAPTER 8, Labware Catalog Page; Figure 8.71, About Page; CHAPTER 8, Zonal/Continuous Flow Operation Page; CHAPTER 8, Select Rotor and Labware Page (Catalog/Library); Table C.1, Diagnostics/User Messages Chart.

Issue Version AH, 08/2020

Changes or additions were made to: Software Copyright; Figure 2.23, About Page; CHAPTER 4, Configuration; CHAPTER 4, Managing Your Network; CHAPTER 4, Setting Up a GMP Network; CHAPTER 4, Managing Reports CHAPTER 4, Export Data; CHAPTER 4, Signature Options; CHAPTER 4, Managing Qualifications; Figure 8.33, System Options Page, Basic Tab; Figure 8.34, System Options Page, System Tab; Figure 8.35, System Options Page, Network Tab; Figure 8.36, System Options Page, Users Tab; CHAPTER 8, The Reports Tab; CHAPTER 8, The Qualification Tab; CHAPTER 8, Setup Network Page; CHAPTER 8, Setup Network Path; CHAPTER 8, About Page; CHAPTER 8, Substitute Rotor Run Page; Table C.1, Diagnostics/User Messages Chart. Removed Appendix D, Third Party Contributions and Legal Notices.

Issue Version AJ, 03/2021

Changes or additions were made to: RoHS Notice; Table C.1, Diagnostics/User Messages Chart.

Issue Version AK, 08/2022

Changes or additions were made to: Safety and Notices, Multiple Compliance; CHAPTER 1, Physical Data; CHAPTER 8, The Network Tab; CHAPTER 8, Setup Network Path.

Issue Version AL, 03/2023

Changes or additions were made to: [CHAPTER 1, Physical Data](#).

Note: Changes that are part of the most recent revision are indicated in text by a bar in the margin of the amended page.

This document applies to the latest software listed and higher versions. When a subsequent software version affects the information in this document, a new issue will be released to the Beckman Coulter website. For labeling updates, go to www.beckman.com and download the latest version of the manual or system help for your instrument.

Safety and Notices

This chapter presents the important notices that apply to the instrument and describes the conventions used in the document.

Alerts for Danger, Warning, Caution, Important, and Note

DANGER

DANGER indicates an imminently hazardous situation which, if not avoided, will result in death or serious injury. This signal word is to be limited to the most extreme situations.

WARNING

WARNING indicates a potentially hazardous situation which, if not avoided, could result in death or serious injury. May be used to indicate the possibility of erroneous data that could result in an incorrect diagnosis (does not apply to all products).

CAUTION

CAUTION indicates a potentially hazardous situation, which, if not avoided, may result in minor or moderate injury. It may also be used to alert against unsafe practices. May be used to indicate the possibility of erroneous data that could result in an incorrect diagnosis (does not apply to all products).

IMPORTANT IMPORTANT is used for comments that add value to the step or procedure being performed. Following the advice in the Important adds benefit to the performance of a piece of equipment or to a process.

NOTE NOTE is used to call attention to notable information that should be followed during installation, use, or servicing of this equipment.

Safety Notices

Before installing, using, or maintaining the instrument, be certain that you know all the following precautions.

Information

CAUTION

Read all product manuals and consult with Beckman Coulter-trained personnel before attempting to operate instrument. Do not attempt to perform any procedure before carefully reading all instructions. Always follow product labeling and manufacturer's recommendations. If in doubt as to how to proceed in any situation, contact your Beckman Coulter Representative.

Installation

CAUTION

This instrument is designed to be installed by a Beckman Coulter Field Service representative. Installation by anyone other than authorized Beckman Coulter personnel invalidates any warranty covering the instrument. Also, should the instrument need to be moved, a Beckman Coulter Field Service representative must reinstall and re-level the instrument in its new location.

WARNING

Do not place the ultracentrifuge near areas containing flammable or combustible fluids, or any other source of vapors that could enter the ultracentrifuge air system and be ignited by the motor.

WARNING

Ultracentrifuge operations generate high energy levels that require precautions against sudden movements that could result from the rare event of a rotor failure. Maintain a 30-cm. (1-ft.) clearance envelope around and above the ultracentrifuge. Do not install any equipment or furniture in this envelope. While the ultracentrifuge is running, keep the envelope clear of any persons or objects and do not reach into the envelope except when required to change operating controls.

Replacement Parts

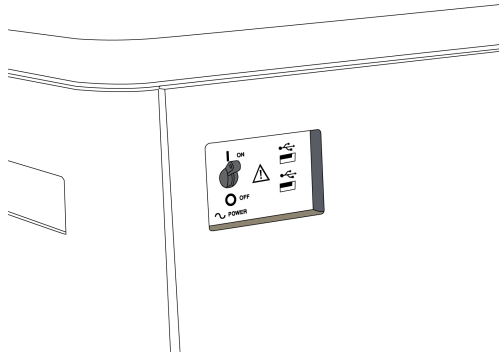
WARNING

Do not replace any centrifuge components with parts not specified for use on this instrument.

Service

 **WARNING**

Any servicing of this equipment that requires removal of any covers can expose parts which involve the risk of electric shock or personal injury. Make sure that the power switch is turned off, and the instrument is disconnected from the main power source, by removing its power plug from the receptacle. Refer such servicing to qualified personnel.



NOTE It is your responsibility to decontaminate the instrument and accessories before requesting service by Beckman Coulter Field Service.

Power Supply

 **DANGER**

To reduce the risk of electrical shock, this instrument uses a three-wire electrical cord and plug to connect this equipment to earth-ground. Make sure that the matching wall outlet receptacle is properly wired and earth-grounded.

Fuse Replacement

 **WARNING**

Fuses protect certain electrical circuits within this instrument against overcurrent conditions. The fuse is not customer replaceable. For continued protections, please contact Beckman Coulter Field Service.

Mechanical Safety

 **DANGER**

For safe operation of the equipment, observe the following:

- Use only the Beckman Coulter rotors and accessories designed for use in this instrument.

- Do not exceed the maximum rated speed of the rotor in use.
- NEVER attempt to slow or stop a rotor by hand.
- Do not move the centrifuge while the drive motor is spinning.
- In the event of a power failure, do not attempt to retrieve the sample from the instrument for at least one hour. Then follow the instructions for recovery of the sample in the *Maintenance and Troubleshooting* chapter.

Chemical and Biological Safety

DANGER

Normal operation may involve the use of solutions and test samples that are pathogenic, toxic, or radioactive. Such materials require that you take all necessary safety precautions.

- Handle body fluids with care because they can transmit disease. No known test offers complete assurance that they are free of micro-organisms.
- Handle all infectious samples according to good laboratory procedures and methods to prevent spread of disease.
- Because spills may generate aerosols, observe proper safety precautions for aerosol containment.
- Some of the most virulent infectious agents—Hepatitis (B and C) and HIV (I-V) viruses, atypical mycobacteria, and certain systemic fungi—require additional emphasis on aerosol protection.
- Do not run toxic, pathogenic, or radioactive materials in a rotor without taking appropriate safety precautions.
- Risk Group II materials (as identified in the World Health Organization Laboratory Biosafety Manual) require biosafe containment. Materials of a higher group require more than one level of protection.
- Dispose of all waste solutions according to appropriate environmental health and safety guidelines.
- Do not centrifuge flammable or explosive vapors, or materials capable of hazardous chemical reactions.

Precautions with Liquids

WARNING

Do not place containers holding liquid on or near the chamber door. Liquid, if spilled, may get into the instrument and damage electrical or mechanical components.

Volatile Liquids



This instrument is not designed for use with materials capable of developing flammable or explosive vapors, or hazardous chemical reactions. Do not centrifuge such materials (for example, chloroform or ethyl alcohol) in this instrument nor handle or store them near the centrifuge.

Certification

To ensure full system quality, Beckman Coulter Optima XPNs have been manufactured in a registered ISO 9001 or 13485 facility. They have been designed and tested to conform to (when used with Beckman Coulter rotors) the laboratory equipment requirements of applicable regulatory agencies. Declarations of conformity and certificates of compliance are available at www.beckman.com.

Scope of Manual

This manual is designed to familiarize you with the Optima XPN, its functions, specifications, operation, and routine operator care and maintenance. Read this entire manual, especially the safety notices and all safety-related information, before operating the instrument or performing maintenance.

NOTE If the instrument is used in a manner other than specified in this manual, the safety and performance of this equipment could be impaired. Further, the use of any equipment other than that recommended by Beckman Coulter has not been evaluated for safety. Use of any equipment not specifically recommended in this manual and/or the appropriate rotor manual is the sole responsibility of the user.

CFC-Free Centrifugation



To ensure minimal environmental impact, no CFCs are used in the manufacture or operation of the Optima XPN ultracentrifuge.

Software Copyright

The software and other information incorporated into the Optima XPN is protected by international copyright laws. Unauthorized copying, use, distribution, transfer, or sale is a violation of those laws that may result in civil or criminal penalties.

RoHS Notice

These labels and materials declaration table (the Table of Hazardous Substance's Name and Concentration) are to meet People's Republic of China Electronic Industry Standard SJ/T11364-2006 "Marking for Control of Pollution Caused by Electronic Information Products" requirements.

China RoHS Caution Label



This label indicates that the electronic information product contains certain toxic or hazardous substances. The center number is the Environmentally Friendly Use Period (EFUP) date, and indicates the number of calendar years the product can be in operation. Upon the expiration of the EFUP, the product must be immediately recycled. The circling arrows indicate the product is recyclable. The date code on the label or product indicates the date of manufacture.

Summary of Instrument Labels

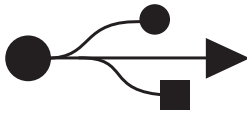
This section provides information for some labels and symbols appearing on the Optima XE instrument housing. These labels and symbols may be associated with user-serviceable procedures. Individual hazards associated with a specific procedure in this manual may use these labels and symbols, and are included in **Warnings** or **Cautions** within the procedures for that task.

Caution Symbol



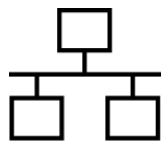
This symbol indicates a caution message and appears adjacent to an explanation or other symbols that define the caution.

Universal Serial Bus (USB)



This symbol indicates the location of a universal serial bus (USB) connector.

Ethernet



This symbol indicates the location of an ethernet connector.

Recycling Label



This symbol is required in accordance with the Waste Electrical and Electronic Equipment (WEEE) Directive of the European Union. The presence of this marking on the product indicates:

- the device was put on the European Market after August 13, 2005 and
- the device is not to be disposed of via the municipal waste collection system of any member state of the European Union.

It is very important that customers understand and follow all laws regarding the proper decontamination and safe disposal of electrical equipment. For Beckman Coulter products bearing this label, please contact your dealer or local Beckman Coulter office for details on the take-back program that will facilitate the proper collection, treatment, recovery, recycling and safe disposal of the device.

Multiple Compliance



This symbol indicates compliance with:

- 169502 – This label indicates recognition by a Nationally Recognized Testing Laboratory (NRTL) that the instrument has met the relevant product safety standards.
- The RCM mark is intended for use on products that comply with Australian communications Media Authority (ACMA) EMC Requirements.
- Recycling – Refer to the Recycling Label section in this document.
- **CE** – A “CE” mark indicates that a product has been assessed before being placed on the market, and has been found to meet European Union safety, health, and/or environmental protection requirements.
- **UK CA** – A "UKCA" mark indicates that a product has been assessed before being placed in UK market, and has been found to UK safety, health, and/or environmental protection requirements.

CAUTION Static Sensitive Area



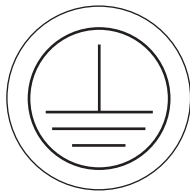
Indicates an area of the instrument which is sensitive to static electrostatic discharge (ESD). To prevent damage due to electrostatic discharge, always wear a properly earth-grounded wrist strap while operating this instrument. For details on proper grounding, see IEEE standard P1100.

DANGER High Voltage



Operation, replacement or servicing of any components where contact with bare, live hazardous parts could occur, possibly resulting in electric shock, should only be performed by your Beckman Coulter representative.

Protective Ground



This symbol is used to indicate a protective ground. This instrument must be properly grounded. Do not under any circumstances operate the instrument unless it is properly grounded.

Alternating Current



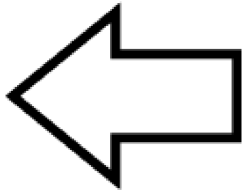
This symbol is used to indicate an alternating current (also known as “AC”).

Output Plate Label

| |
|---|
| Utility Interactive |
| Output: 200-240 VAC, 50/60 Hz, 8.5A, 0.99pf |
| Max Output Power: 1.7kW |
| Max Output Fault Current: 20A |
| Max Ambient: 35C |
| This unit or system is provided with fixed trip limits |
| and shall not be aggregated above 30kW on a single Point of Common Connection. |





This is the label that indicates what the output rating are on the instrument.

Rotor Rotation



This indicates the direction of instrument rotor rotation.

Symbols

| Symbol Symbol Symbole Simbolo | Simbolo 記号 符号 | Title / Titel / Titre / Titolo / Titolo / 名称 / 名称 |
|---|---------------------|--|
|  | | Dangerous voltage Gefährliche elektrische Spannung Courant haute tension Voltaje peligroso Pericolo: alta tensione 危険電圧 危険电压 |
|  | | Attention, consult accompanying documents Achtung! Begleitpapiere beachten! Attention, consulter les documents joints Atención, consulte los documentos adjuntos Attenzione: consultare le informazioni allegate 注意、添付資料を参照のこと 注意，请参阅附带的文件 |
|  | | On (power) Ein (Netzverbindung) Marche (mise sous tension) Encendido Acceso (sotto tensione) 入（電源） 开（电源） |
|  | | Off (power) Aus (Netzverbindung) Arrêt (mise hors tension) Apagado Spento (fuori tensione) 切（電源） 关（电源） |
|  | | Protective earth (ground) Schutzleiteranschluß Liaison à la terre Puesta a tierra de protección Collegamento di protezione a terra 保護アース（接地） 保护接地 |
|  | | Earth (ground) Erde Terre Tierra Scarica a terra アース（接地） 接地 |
|  | | Alternating Current Wechselstrom Courant alternatif Corriente Alterna Corrente Alternata 交流 交流电 |

Contents

Revision History, iii

Safety and Notices, v

Alerts for Danger, Warning, Caution, Important, and Note, v

Safety Notices, v

Information, vi

Installation, vi

Replacement Parts, vi

Service, vi

Power Supply, vii

Fuse Replacement, vii

Mechanical Safety, vii

Chemical and Biological Safety, viii

Precautions with Liquids, viii

Volatile Liquids, ix

Certification, ix

Scope of Manual, ix

CFC-Free Centrifugation, x

Software Copyright, x

RoHS Notice, x

China RoHS Caution Label, x

Summary of Instrument Labels, x

Caution Symbol, xi

Universal Serial Bus (USB), xi

Ethernet, xi

Recycling Label, xi

Multiple Compliance, xii

CAUTION Static Sensitive Area, xii

DANGER High Voltage, xiii

Protective Ground, xiii

Alternating Current, xiii

Output Plate Label, xiv

Rotor Rotation, xiv

Symbols, xv

CHAPTER 1: Description, 1-1

Touch Screen, 1-1

Name Rating Plate, 1-1

- Rotor Chamber, 1-1
- Vacuum System, 1-1
- Temperature Sensing and Control, 1-2
- Drive, 1-2
- Safety Features, 1-2
 - Door, 1-2
 - Barrier Ring, 1-3
 - Imbalance Detector, 1-3
 - Overspeed System, 1-3
 - Dynamic Rotor Inertia Check (DRIC), 1-3
- Specifications, 1-3
 - Control Features, 1-4
 - Physical Data, 1-6
 - Audible Sounds, 1-7
- Available Rotors, 1-9

CHAPTER 2: The Touch Screen Interface, 2-1

- Areas on the Screen, 2-1
 - Header Bar, 2-1
 - Home Page Button, 2-2
 - Menu Button, 2-2
 - Status Display, 2-2
 - Help Button, 2-3
 - Footer Bar, 2-3
 - Start Button, 2-4
 - Stop Button, 2-4
 - Footer Bar on the Home Page, 2-5
 - Footer Bar on Other Pages, 2-5
 - Vacuum Display/Button, 2-5
 - System Name, 2-5
 - Accel and Decel Display/Button, 2-6
 - Page Display Area, 2-6
- Help Messages, 2-6
 - Item Help, 2-6
 - Global Help, 2-7
- System References, 2-8
- About Your Instrument, 2-9

CHAPTER 3: Operations, 3-1

- Manual Operation, 3-1
 - Step 1: Start on the Home Page, 3-2
 - Step 2: Set the Speed and Rotor, 3-3
 - Step 3: Set the Acceleration and Deceleration Profiles, 3-5
 - Step 4: Set the Time, 3-6

Step 5: Set the Temperature, 3-7

Step 6: Start the Run, 3-9

Zonal and Continuous Flow Operation, 3-10

Preparing for the Run, 3-11

Starting the Run, 3-11

Loading the Sample, 3-12

Running the Sample, 3-12

Unloading the Sample, 3-13

Stopping the Run, 3-13

Finishing the Run, 3-13

CHAPTER 4: Configuration, 4-1

Managing Your Network , 4-1

Setting Up the Network , 4-1

Selecting a Printer, 4-2

Setting Up Email , 4-2

Setting Up VNC, 4-3

Enabling API, 4-4

Setting Up a GMP Network, 4-4

Managing Users, 4-4

Adding Users, 4-5

Requiring Login, 4-5

PIN Expiration and Logout Timer, 4-6

User Options, 4-7

Managing Rotors, 4-7

Adding Rotors, 4-8

Requiring Rotor Selection, 4-8

Managing Reports, 4-9

User Access, 4-9

Filter Data, 4-9

Graph Data, 4-11

Print Data, 4-13

Export Data, 4-14

Auto Print and Auto Export Run History Data, 4-15

To enable Auto Print: , 4-15

To enable Auto Export:, 4-16

Run Comments, 4-16

Signature Options, 4-18

Managing Qualifications, 4-20

CHAPTER 5: Programs, 5-1

Creating Programs, 5-1

Running Programs, 5-5

Editing Programs, 5-6

Deleting Programs, 5-6

CHAPTER 6: Calculations , 6-1

Using Calculations, 6-1

Calculations Page, 6-1

Reduce Rotor Speed For Dense Solutions, 6-3

Reduce Rotor Speed For Precipitating Solutions, 6-4

Sedimentation Coefficient From Run Data, 6-5

Sedimentation Coefficient From Molecular Mass , 6-7

Pelleting Time, 6-8

Refractive Index , 6-9

Concentration Measures , 6-10

CHAPTER 7: Simulations , 7-1

Using Simulations, 7-1

Simulations Page, 7-1

ESP RNA Pelleting Best Run, 7-3

ESP RNA Pelleting Fast Run, 7-5

ESP Pelleting Run, 7-6

ESP Rate Zonal Run, 7-8

ESP Plasmid Run, 7-9

Substitute Rotor Run, 7-11

CHAPTER 8: Functional Pages, 8-1

Home Page, 8-3

Home Page (Run in Progress), 8-5

Set Speed Page, 8-6

Select Rotor and Labware Page (Library), 8-7

Set Time Page, 8-8

Delay Start Page, 8-9

Set Speed ω^2t Time Page, 8-10

Set Temperature Page, 8-11

Set Acceleration/Deceleration Profiles Page, 8-12

Example Acceleration and Deceleration Profiles, 8-13

Login Page, 8-14

Select Program Page, 8-15

New/Edit/View Program Page, 8-16

Select Rotor and Labware Page (Catalog), 8-18

New/Edit Step Page, 8-19

Program Log Page, 8-20

Export Page, 8-21

Authorize Users Page, 8-22

| |
|---|
| Import Page, 8-23 |
| Real-Time Run Data/Historical Run Data Page, 8-24 |
| Run Graph Options Page, 8-25 |
| Run History Page, 8-26 |
| Run History Filter Page, 8-28 |
| Before Run/After Run Comment Page, 8-29 |
| Menu Page, 8-30 |
| System Options Page, 8-31 |
| The Basic Tab, 8-31 |
| The System Tab, 8-32 |
| The Network Tab, 8-33 |
| The Users Tab, 8-34 |
| The Reports Tab, 8-35 |
| The Qualification Tab, 8-36 |
| Select Language Page, 8-37 |
| User Options Page, 8-38 |
| Reset User PIN Page, 8-39 |
| Select Image Page, 8-40 |
| Set Date and Time Page, 8-41 |
| System Log Page, 8-42 |
| Manage Rotors Page, 8-43 |
| Add to Rotor Library Page, 8-44 |
| Diagnostic History Page, 8-45 |
| Set Sound Page, 8-46 |
| Custom Sounds Page, 8-47 |
| Archive Data Page, 8-48 |
| Setup Network Page, 8-49 |
| Setup Network Path, 8-50 |
| Select Printer Page, 8-51 |
| Setup Email Page, 8-52 |
| Setup VNC Page, 8-53 |
| Manage Users Page, 8-54 |
| Add/Edit User Page, 8-55 |
| Authorize Programs Page, 8-56 |
| References Page, 8-57 |
| Rotor Catalog Page, 8-58 |

Compatible Tubes for Rotor Page, 8-59

Labware Catalog Page, 8-60

Chemical Resistances Page, 8-61

Calculations Page , 8-62

Reduce Rotor Speed for Dense Solutions Page, 8-63

Reduce Rotor Speed for Precipitating Solutions Page, 8-64

Determine Sedimentation Coefficient from Run Data Page, 8-65

Determine Sedimentation Coefficient from Molecular Mass Page, 8-66

Calculate Pelleting Time Page, 8-67

Calculate Concentration Measures Page, 8-68

Calculate Refractive Index Page, 8-69

About Page, 8-70

Zonal/Continuous Flow Authorization Page, 8-71

Zonal/Continuous Flow Operation Page, 8-72

Simulations Page , 8-73

ESP RNA Pelleting in CsCl with GuSCN, Optimized for Purity Page, 8-74

Select Rotor and Labware Page (Catalog/Library), 8-76

ESP RNA Pelleting in CsCl with GuSCN, Optimized for Speed Page, 8-77

ESP Pelleting Separation Page, 8-78

ESP Optimized Plasmid DNA Separation Page, 8-79

ESP Rate Zonal Separation Page, 8-80

Substitute Rotor Run Page, 8-82

CHAPTER 9: Maintenance and Troubleshooting, 9-1

Field Service, 9-1

Rotors and Labware, 9-1

Cleaning, 9-1

- Instrument Surfaces, 9-1
- Rotor Chamber, 9-2
- Chamber Door O-ring, 9-2

Decontamination, 9-2

Sterilization and Disinfection, 9-2

Diagnostics/User Messages, 9-3

Retrieving Your Sample in Case of Power Failure, 9-3

- During a Run, 9-3
- Rotor Spinning at Restoration, 9-3

Rotor Stopped at Restoration, 9-3
Getting Access to the Sample, 9-4
Restoring the Instrument to Operating Condition, 9-9

Storage and Transportation, 9-10

Supply List, 9-11

Replacement Parts, 9-11

Supplies, 9-11

APPENDIX A: Preinstallation Requirements, A-1

Overview, A-1

Space Requirements, A-1

Safety, A-1

Ventilation, A-2

Temperature, A-2

Electrical Requirements, A-2

APPENDIX B: Special Warranty for the Optima XPN, B-1

Special Warranty, B-1

APPENDIX C: Diagnostics, C-1

Overview, C-1

Diagnostics/User Messages Chart, C-1

Illustrations

- 2.1 Home Page, 2-1
- 2.2 Header Bar, 2-1
- 2.3 Home Page Button, 2-2
- 2.4 Menu Button, 2-2
- 2.5 Ready Status, 2-2
- 2.6 Header Bar - Ready Status, 2-3
- 2.7 Header Bar - Running Status, 2-3
- 2.8 Header Bar - Stopping Status, 2-3
- 2.9 Header Bar - Warning Message, 2-3
- 2.10 Header Bar - Error Message, 2-3
- 2.11 Help Button, 2-3
- 2.12 Start Button, 2-4
- 2.13 Stop Button, 2-4
- 2.14 Footer Bar - Home Page, 2-5
- 2.15 Footer Bar on Other Pages, 2-5
- 2.16 Item Help Button, 2-6
- 2.17 Global Help Button attached to Help Button, 2-7
- 2.18 Home Page Help with ghost image, 2-7
- 2.19 Transparency Button, 2-7
- 2.20 Home Page Help with opaque screen, 2-8
- 2.21 Help Navigation Buttons, 2-8
- 2.22 References Page, 2-9
- 2.23 About Page, 2-10
- 3.1 Home Page, 3-2
- 3.2 Zonal Operation Page with Cancel Button, 3-3
- 3.3 Set Speed Page, 3-3
- 3.4 Select Rotor and Labware Page, 3-4
- 3.5 Set Acceleration/Deceleration Profiles Page, 3-5
- 3.6 Set Time Page, 3-6
- 3.7 Delay Start Page, 3-7
- 3.8 Set Temperature Page, 3-8
- 3.9 Start Button, 3-9
- 3.10 Zonal Page, 3-10

- 3.11 Continuous Flow Page, 3-12
- 4.1 Run History Button, 4-9
- 4.2 Run History Filter, 4-10
- 4.3 Set From Date and Time, 4-10
- 4.4 Run History, 4-11
- 4.5 Run Graph Button, 4-11
- 4.6 Run History Button, 4-12
- 4.7 Run Graph Options, 4-12
- 4.8 Run Graph Button, 4-13
- 4.9 Run History Button, 4-13
- 4.10 Run History Button, 4-14
- 4.11 Run History, 4-14
- 4.12 Run History Button, 4-15
- 4.13 Before Run Comment, 4-17
- 4.14 Signature, 4-19
- 4.15 System Options - Qualification, 4-20
- 4.16 Qualification Management, 4-21
- 5.1 Program Button, 5-1
- 5.2 Home, 5-1
- 5.3 Select Program, 5-2
- 5.4 Unnamed program, 5-2
- 5.5 New Program Name, 5-3
- 5.6 Set Acceleration/Deceleration Profiles, 5-3
- 5.7 Select Rotor and Labware, 5-4
- 5.8 New Step, 5-4
- 5.9 New Step in a numbered sequence, 5-5
- 5.10 Program Button, 5-5
- 5.11 Program Button, 5-6
- 5.12 Program Button, 5-6
- 6.1 Menu Page, 6-2
- 6.2 Calculations Page, 6-3
- 6.3 Reduce Rotor Speed for Dense Solutions Page, 6-4
- 6.4 Reduce Rotor Speed for Precipitating Solutions Page, 6-5
- 6.5 Determine Sedimentation Coefficient From Run Data Page, 6-6
- 6.6 Determine Sedimentation Coefficient from Molecular Mass Page, 6-7
- 6.7 Pelleting Time Page, 6-8
- 6.8 Calculate Refractive Index Page, 6-10

| | |
|------|--|
| 6.9 | Calculate Concentration Measures Page, 6-11 |
| 7.1 | Menu Page, 7-2 |
| 7.2 | Simulations Page, 7-3 |
| 7.3 | ESP RNA Pelleting in CsCl with GuSCN, Optimized for Purity Page, 7-4 |
| 7.4 | ESP RNA Pelleting in CsCl with GuSCN, Optimized for Speed Page, 7-5 |
| 7.5 | ESP Pelleting Separation Page, 7-7 |
| 7.6 | ESP Rate Zonal Separation Page, 7-8 |
| 7.7 | ESP Optimized Plasmid DNA Separation Page, 7-10 |
| 7.8 | Substitute Rotor Run Page, 7-11 |
| 8.1 | Home Page, 8-3 |
| 8.2 | Home Page (Run in Progress), 8-5 |
| 8.3 | Set Speed Page (No Rotor Selected), 8-6 |
| 8.4 | Set Speed Page (Rotor and Labware Selected), 8-6 |
| 8.5 | Select Rotor and Labware Page (Library), 8-7 |
| 8.6 | Set Time Page, 8-8 |
| 8.7 | Delay Start Page, 8-9 |
| 8.8 | Set Speed ω^2t Time Page, 8-10 |
| 8.9 | Set Temperature Page, 8-11 |
| 8.10 | Set Acceleration/Deceleration Profiles Page, 8-12 |
| 8.11 | Login Page, 8-14 |
| 8.12 | Select Program Page, 8-15 |
| 8.13 | New Program Page, 8-16 |
| 8.14 | Edit Program Page, 8-16 |
| 8.15 | View Program Page, 8-17 |
| 8.16 | Select Rotor and Labware Page (Catalog), 8-18 |
| 8.17 | New Step Page, 8-19 |
| 8.18 | Edit Step Page, 8-19 |
| 8.19 | Program Log Page, 8-20 |
| 8.20 | Export Page, 8-21 |
| 8.21 | Authorize Users Page, 8-22 |
| 8.22 | Import Page, 8-23 |
| 8.23 | Real-Time Run Data Page, 8-24 |
| 8.24 | Historical Run Data Page, 8-24 |
| 8.25 | Run Graph Button, 8-25 |
| 8.26 | Run Graph Options Page, 8-25 |
| 8.27 | Run History Page, 8-26 |

- 8.28 Run History Page (E-Signature Enabled), 8-27
- 8.29 Run History Button, 8-27
- 8.30 Run History Filter Page, 8-28
- 8.31 Before Run Comment Page, 8-29
- 8.32 Menu Page, 8-30
- 8.33 System Options Page, Basic Tab, 8-31
- 8.34 System Options Page, System Tab, 8-32
- 8.35 System Options Page, Network Tab, 8-33
- 8.36 System Options Page, Users Tab, 8-34
- 8.37 System Options Page, Reports Tab, 8-35
- 8.38 The Qualification Tab, 8-36
- 8.39 Select Language Page, 8-37
- 8.40 User Options Page, 8-38
- 8.41 Reset User PIN Page, 8-39
- 8.42 Select Image Page (Avatar), 8-40
- 8.43 Select Image Page (Background), 8-40
- 8.44 Set Date and Time Page, 8-41
- 8.45 System Log Page, 8-42
- 8.46 Manage Rotors Page, 8-43
- 8.47 Add to Rotor Library Page, 8-44
- 8.48 Diagnostic History Page, 8-45
- 8.49 Set Sound Page, 8-46
- 8.50 Custom Sounds Page, 8-47
- 8.51 Archive Data Page, 8-48
- 8.52 Setup Network Page, 8-49
- 8.53 Setup Network Path, 8-50
- 8.54 Select Printer Page, 8-51
- 8.55 Setup Email Page, 8-52
- 8.56 Setup VNC Page, 8-53
- 8.57 Manage Users Page, 8-54
- 8.58 Add User Page, 8-55
- 8.59 Authorize Programs Page, 8-56
- 8.60 References Page, 8-57
- 8.61 Rotor Catalog Page, 8-58
- 8.62 Compatible Tubes for Rotor Page, 8-59
- 8.63 Labware Catalog Page, 8-60
- 8.64 Chemical Resistance Page, 8-61
- 8.65 Calculations Page, 8-62

| | |
|------|---|
| 8.66 | Reduce Rotor Speed for Dense Solutions Page, 8-63 |
| 8.67 | Reduce Rotor Speed for Precipitating Solutions Page, 8-64 |
| 8.68 | Determine Sedimentation Coefficient from Run Data Page, 8-65 |
| 8.69 | Determine Sedimentation Coefficient from Molecular Mass Page, 8-66 |
| 8.70 | Calculate Pelleting Time Page, 8-67 |
| 8.71 | Calculate Concentration Measures Page, 8-68 |
| 8.72 | Calculate Refractive Index Page, 8-69 |
| 8.73 | About Page, 8-70 |
| 8.74 | Zonal Authorization Page, 8-71 |
| 8.75 | Zonal Mode Button, 8-71 |
| 8.76 | Zonal Operation Page, 8-72 |
| 8.77 | Continuous Flow Operation Page, 8-72 |
| 8.78 | Simulations Page, 8-73 |
| 8.79 | ESP RNA Pelleting in CsCl with GuSCN, Optimized for Purity Page, 8-74 |
| 8.80 | Select Rotor and Labware Page (Catalog/Library), 8-76 |
| 8.81 | ESP RNA Pelleting in CsCl with GuSCN, Optimized for Speed Page, 8-77 |
| 8.82 | ESP Pelleting Separation Page, 8-78 |
| 8.83 | ESP Optimized Plasmid DNA Separation Page, 8-79 |
| 8.84 | ESP Rate Zonal Separation Page, 8-80 |
| 8.85 | Substitute Rotor Run Page, 8-82 |
| 9.1 | Panel screws and Tabs, 9-5 |
| 9.2 | Internal Parts — Configuration “A” vents through the port cap, 9-6 |
| 9.3 | Internal Parts — Configuration “B” vents through the vacuum solenoid release screw, 9-7 |
| A.1 | Safety and ventilation space, A-2 |
| A.2 | Electrical Connection, A-3 |

Tables

| | |
|-----|--------------------------------------|
| 4.1 | User Levels, 4-5 |
| A.1 | Required Wire Connections, A-3 |
| C.1 | Diagnostics/User Messages Chart, C-1 |

CHAPTER 1

Description

The Optima XPN generates centrifugal forces for the separation of particles. Classified S, it can be used with all currently manufactured Beckman Coulter rotors for floor-model preparative ultracentrifuges.

This chapter describes the major components of the instrument.

Touch Screen

The touch screen is both the information display and the control input for the instrument. As they are needed, control buttons appear on the screen. When you select a button, you activate that control.

The touch screen position is adjustable (both swivel and tilt) to be made viewable from nearly anywhere in the lab. This is especially useful in environments where a single operator may oversee a number of instruments.

Each component of the touch screen interface is explained in the following chapters.

Name Rating Plate

A name rating plate is affixed to the rear of the instrument. Always mention the serial number and model number (available on the [About Page](#)) when contacting Beckman Coulter regarding your instrument.

Rotor Chamber

The rotor chamber is made of aluminum and coated with a chemical-resistant epoxy finish. The central feature is the rotor drive spindle, but several sensors and control systems are also contained in the rotor chamber.

Vacuum System

The Optima XPN uses a diffusion pump in series with a mechanical vacuum pump to reduce chamber pressure to a very low level. The system starts automatically when you start a run, or manually when the chamber door is closed and you use the **Vacuum** Display/Button on the Footer Bar of the Home Page. When the vacuum system is on, the chamber pressure is displayed in microns in the **Vacuum** Display/Button.

Description

Temperature Sensing and Control

At the end of a run, select the **Vacuum** Display/Button to vent the chamber vacuum before attempting to open the door. When the chamber vacuum is reduced to the point that you can open the door, the system sounds an audible tone. (See [Audible Sounds](#).) After you open the door, there is a five minute period where the chamber temperature remains as set (to allow back-to-back runs). Then the chamber returns to approximate room temperature to minimize condensation collecting in the chamber. To help keep the chamber dry and clean, keep the door closed whenever possible. If you wish to vent the chamber before the rotor has come to a complete stop, you can do so as soon as it slows below 3000 rpm.

In Zonal or Continuous Flow operation, the door may remain open while the rotor is spinning up to the loading speed. The vacuum system is activated when the door is closed and the rotor speed is above 3000 rpm (after loading the rotor). Normally, you vent the chamber at the end of the run when the rotor has decelerated to the unloading speed, but you can vent the chamber when the rotor has decelerated below 3000 rpm if the unloading speed is slower than that.

Temperature Sensing and Control

A solid state thermopile in the bottom of the rotor chamber monitors rotor temperature.

The Optima XPN uses a solid state thermoelectric refrigeration and heating system without coolant or water. Cooling is provided by forced air from the fans.

When the power is on, the temperature control system starts when the door is closed and the vacuum system is running.

Drive

The frequency-controlled, air-cooled, direct-drive induction motor requires no gears or brushes. In addition, the drive does not require an oil vacuum seal, external oil reservoir, or continuously operating damper. Externally cooled by forced air and internally cooled by oil, the drive delivers ultra-smooth, quiet performance, with high rotor-imbalance tolerance.

Safety Features

The Optima XPN ultracentrifuge has been designed and tested to operate safely indoors at altitudes up to 2000 m (6562 ft.).

Door

The high-strength structural steel chamber door has a solenoid interlock to prevent operator contact with a spinning rotor. When the door is closed and a run begins, it locks automatically. It can be opened only when the power is on and the rotor is at rest with the chamber at atmospheric pressure. If there is a power failure, you can manually unlock the door as described in the [Maintenance and Troubleshooting](#) chapter.

Barrier Ring

A 41-mm (1.63-in.) steel alloy armor ring acts as the primary barrier, surrounded by a 13-mm (0.5-in.) vacuum chamber to provide full protection for the operator.

Imbalance Detector

An imbalance detector monitors the rotor during the run, causing automatic shutdown if rotor loads are severely out of balance. Even at low speeds, an incorrectly loaded rotor can cause an imbalance.

Overspeed System

The overspeed system is a safety feature designed to ensure that the rotor does not exceed its maximum allowable speed. This system includes a photoelectric device in the rotor chamber next to the drive spindle and an overspeed disk on the bottom of the rotor. Individual rotor manuals provide information on the correct overspeed disks to be used with each rotor.

The overspeed disk has alternating light and dark sectors. As the rotor spins, the passage of reflecting and non-reflecting sectors over the photoelectric device generates a series of pulses detected by the electronic circuitry and software.

After the rotor reaches 600 rpm, the set speed is checked against the overspeed disk. If the set speed is greater than the maximum speed permitted by the disk, the speed setting is automatically lowered to the maximum speed of the disk, but the run continues without interruption. An alert appears to alert you to the change.

Dynamic Rotor Inertia Check (DRIC)

As the rotor accelerates between 15000 and 20000 rpm, the instrument checks the rotor inertia and calculates the rotor energy for the speed set by the user. If the calculated rotor energy is excessive, the instrument first attempts to reduce the speed to an appropriate level and continues the run. The system displays an alert message to notify you of this change. If a safe speed cannot be determined, the instrument stops the run with braking to avoid possible damage.

Specifications

Only values with tolerances or limits are guaranteed data. Values without tolerances are informative data, without guarantee.

Control Features

| Specifications | Description |
|---------------------|---|
| <p>Speed</p> | <ul style="list-style-type: none"> • Set speed: <ul style="list-style-type: none"> — 1,000 to rated speed in 100-rpm increments • Maximum speed: <ul style="list-style-type: none"> — XPN-80: 80,000 rpm — XPN-90: 90,000 rpm — XPN-100: 100,000 rpm • Speed display: <ul style="list-style-type: none"> — Actual measured rotor speed in 10-rpm increments below 1000 rpm and 100-rpm increments ≥ 1000 rpm • Speed control: <ul style="list-style-type: none"> — Actual measured rotor speed, ± 2 rpm at steady state (1,000 rpm to rated speed) • Acceleration: <ul style="list-style-type: none"> — 10 profiles • Deceleration: <ul style="list-style-type: none"> — 11 profiles, including coast • Braking: <ul style="list-style-type: none"> — Regenerative, power reclamation |
| <p>Time</p> | <ul style="list-style-type: none"> • Set time: <ul style="list-style-type: none"> — Up to 999 hours 59 minutes, including Hold runs — Up to 3.94780×10^{14} radians squared per second in ω^2t mode • Time display: <ul style="list-style-type: none"> — Indicates time remaining in timed runs, time elapsed in Hold runs, or estimated time remaining in ω^2t runs • Time accuracy: <ul style="list-style-type: none"> — ± 70 ppm (6 seconds/day) • Run modes: <ul style="list-style-type: none"> — Time, ω^2t, and RCF |

| Specifications | Description |
|---------------------------------|--|
| Temperature | <ul style="list-style-type: none">• Set temperature:<ul style="list-style-type: none">— 0 to 40°C in 1°C increments• Rotor Temperature (after equilibration):<ul style="list-style-type: none">— $\pm 0.5^\circ\text{C}$ over entire set temperature range for all rotors except SW-32— $\pm 0.8^\circ\text{C}$ over entire set temperature range for SW-32• Temperature display:<ul style="list-style-type: none">— Actual rotor temperature in 0.1°C increments• Ambient temperature range:<ul style="list-style-type: none">— 10 to 35°C• Humidity restrictions:<ul style="list-style-type: none">— <80% at <35°C (non-condensing)• Condensation removal:<ul style="list-style-type: none">— Automatic, begins five minutes after vacuum vent• Vacuum:<ul style="list-style-type: none">— Below 5 microns (0.7 Pa) |
| Ease of Use | <ul style="list-style-type: none">• Languages:<ul style="list-style-type: none">— Multi-language support• Help:<ul style="list-style-type: none">— On-screen, context sensitive• Diagnostic messages:<ul style="list-style-type: none">— 10,000 messages saved |
| Data | <ul style="list-style-type: none">• Networking:<ul style="list-style-type: none">— RJ-45 connector• Remote Control:<ul style="list-style-type: none">— Via standard IP protocol• Data Transfer:<ul style="list-style-type: none">— 3 USB 2.0 type A connectors• Run Graphs:<ul style="list-style-type: none">— Speed and temperature vs. time, 5,000 graphs saved• Run Logs:<ul style="list-style-type: none">— 5,000 logs saved |
| Electronic Recordkeeping | <ul style="list-style-type: none">• Users:<ul style="list-style-type: none">— 50 unique users and PINs• Levels of Access:<ul style="list-style-type: none">— Administrator, Super User, and Operator• Rotor Library:<ul style="list-style-type: none">— 75 unique rotors by serial number |

Physical Data

| Specification | Description |
|-------------------------------|--|
| Dimensions | <ul style="list-style-type: none"> • Width : <ul style="list-style-type: none"> — 94.0 cm (37 in.) • Depth: <ul style="list-style-type: none"> — 68.1 cm (26.8 in.) • Height: <ul style="list-style-type: none"> — 125.7 cm (49.5 in.) • Weight <ul style="list-style-type: none"> — 485 kg (1068 lb) |
| Ventilation Clearances | <ul style="list-style-type: none"> • Sides <ul style="list-style-type: none"> — 5.1 cm (2.0 in.) • Rear <ul style="list-style-type: none"> — 15.2 cm (6.0 in.) |
| Finishes | <ul style="list-style-type: none"> • Rotor pad: <ul style="list-style-type: none"> — Coated polycarbonate • Top and Front surfaces: <ul style="list-style-type: none"> — Polyurethane • Other surfaces: <ul style="list-style-type: none"> — Acrylic baked enamel |
| Electrical | <ul style="list-style-type: none"> • Power requirement: <ul style="list-style-type: none"> — 200–240 VAC, 30A branch circuit, 50/60 Hz — Automatic tap selection on every run • Electrical supply: <ul style="list-style-type: none"> — Class I • Power Consumption: <ul style="list-style-type: none"> — 60W in idle — 1.1 kW average running in steady state at 90K rpm • Installation (overvoltage) category: <ul style="list-style-type: none"> — II • LCD Monitor: <ul style="list-style-type: none"> — Wide tilt range, horizontal and vertical |

| Specification | Description |
|----------------------|--|
| Outputs | <ul style="list-style-type: none"> • Power Factor: <ul style="list-style-type: none"> — 0.99 • Nominal Output Voltage: <ul style="list-style-type: none"> — 200/240 • Output Frequency: <ul style="list-style-type: none"> — 50/60 Hz • Max Output Current: <ul style="list-style-type: none"> — 8.5A • Max Fault Current: <ul style="list-style-type: none"> — 20A |
| Environmental | <ul style="list-style-type: none"> • RoHS compliant material: <ul style="list-style-type: none"> — 100% of content • Cooling system: <ul style="list-style-type: none"> — Thermoelectric (no CFC gases used) • Noise output (1m in front of instrument): <ul style="list-style-type: none"> — <55 dBA (Sound pressure level) • Maximum heat dissipation into room under steady-state conditions: <ul style="list-style-type: none"> — 3750 Btu/hr (1.1 kW) • Pollution degree: <ul style="list-style-type: none"> — 2^a • HEPA filter: <ul style="list-style-type: none"> — Available^b |

a. Normally, only non-conductive pollution occurs; occasionally, however, a temporary conductivity caused by condensation must be expected.

b. The use of a HEPA filter on the Optima XPN instruments can increase vacuum pull-down times during normal operation. The vacuum system can be warmed up prior to any scheduled run to reduce pull-down time. This warm up can be accomplished by closing the chamber door, setting the run temperature and manually starting the vacuum system several hours prior to making the scheduled run.

Audible Sounds

The Optima XPN instrument makes an audible sound for the following events:

- Boot up
- Start of Run
- End of Run
- Diagnostics/Alert
- Vacuum low enough to open door
- Door open during Zonal or Continuous Flow mode

Sound volume can be regulated through the [Set Sound Page](#), and some sounds can be customized through the System Options. See [Custom Sounds Page](#).

Description
Specifications

For safety, the Door Open during Zonal or Continuous Flow mode sound cannot be changed or muted. It will play every 5 seconds when the door could be open.

Available Rotors

All currently manufactured Beckman Coulter floor model ultracentrifuge rotors can be used in the Optima XPN ultracentrifuge. The rotors are described in individual manuals that accompany each rotor. Information on rotors and accessories is available in the Rotor Catalog accessible from the touch screen. Additional information is available in *Rotors and Tubes for Preparative Ultracentrifuges* (LR-IM) and in the Beckman Coulter *Ultracentrifuge Rotors, Tubes & Accessories* catalog (publication BR-8101). The Beckman Coulter website, <http://www.beckman.com>, contains additional information about centrifugation processes and products.

Refer to specific rotor manuals for proper installation and removal of rotors from the instrument.

Description
Available Rotors

CHAPTER 2

The Touch Screen Interface

This chapter describes the touch screen interface for the Optima XPN. Except for the power switch, all the controls for the instrument are programmed controls that appear on the touch screen.

Figure 2.1 Home Page



Areas on the Screen

The items on the screen may change, depending on the state of the instrument. There are three areas where items appear on the screen:

- The Header Bar
- The Footer Bar
- The Page Display Area

Header Bar

Figure 2.2 Header Bar



The area across the top of the screen is called the Header Bar, containing four important items:

- **Home** Page Button
- **Menu** Button

- **Status** Display
- **Help** Button

The following sections explain these items.

Home Page Button

Figure 2.3 Home Page Button



The **Home Page** Button displays the [Home Page](#) from any other page. When you use Zonal Mode or Continuous Flow Mode, the **Zonal/Continuous Flow Operation** Page replaces the **Home Page**.

Menu Button

Figure 2.4 Menu Button



The **Menu** Button displays the Menu page, including the following functions:

- Options
- References
- Calculations
- About
- Zonal Operation
- Continuous Flow Operation
- Simulations
- Service Mode

The menu options are explained in the following chapters.

Status Display

Figure 2.5 Ready Status



The Status Display is in the middle of the Header Bar and shows you the current instrument status. The background color of the header bar changes with the type of status:

- Blue background: system ready (no run in progress).

Figure 2.6 Header Bar - Ready Status



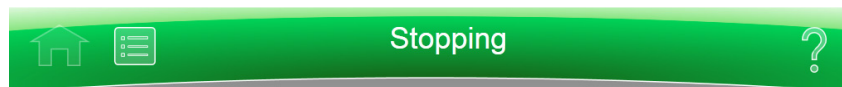
- Green background: in operation (run in progress).

Figure 2.7 Header Bar - Running Status



- Green background: in operation (stop in progress).

Figure 2.8 Header Bar - Stopping Status



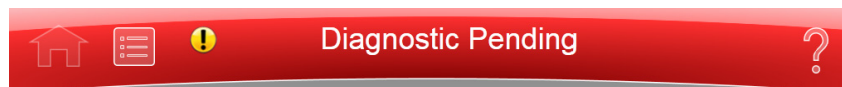
- Yellow background: warning message.

Figure 2.9 Header Bar - Warning Message



- Red background: error message.

Figure 2.10 Header Bar - Error Message



Help Button

Figure 2.11 Help Button



The **Help** button gives you access to the built-in online help messages. Help messages are described at the end of this chapter.

Footer Bar

The bottom of the touch screen always shows the footer bar. The footer bar appears in two different ways, but it always has the **Start** Button at the left and the **Stop** Button at the right.

Start Button

Figure 2.12 Start Button



The **Start** Button begins a run with the current settings. Use it only after you have set the parameters for the run.

Stop Button

Figure 2.13 Stop Button



The **Stop** button stops the current run immediately. This is ordinarily only used for emergencies or if you mistakenly set too long a run time.

Footer Bar on the Home Page

On the **Home** Page, the middle of the Footer Bar shows three Items:

- The **Vacuum** Display/Button
- The System Name
- The **Accel** and **Decel** Display/Button

Figure 2.14 Footer Bar - Home Page



Each of these is explained below.

Footer Bar on Other Pages

When not on the Home Page, the three buttons for Speed, Time and Temperature appear in the Footer Bar for easy access. To set Acceleration or Deceleration profiles, or to use the **Vacuum** button, select the **Home** button to return to the **Home** Page. The following items are described in detail within the **Home** Page section of the next chapter:

- The **Set Speed** Display/Button
- The **Set Time** Display/Button
- The **Set Temp** Display/Button

Figure 2.15 Footer Bar on Other Pages



Vacuum Display/Button

As a display, the **Vacuum** Display/Button shows the current chamber vacuum and the action that will be performed when you select the button. As a control, it serves two functions:

- Before a run, after mounting the rotor and closing the chamber door, select this control to evacuate the chamber and precondition the chamber to the set temperature.
- After a run, select this control to release the vacuum before opening the chamber door.

System Name

The system name displays the system name entered as one of the options on the [System Options Page](#).

Accel and Decel Display/Button

These are two displays that, together, act as a single button.

As a display, each shows the selected acceleration or deceleration profile currently selected. Select the button to display the [Set Acceleration/Deceleration Profiles Page](#), described in [CHAPTER 8](#).

Page Display Area

The Page Display Area is the main display area between the Header Bar and the Footer Bar. The pages and help messages all appear in this area. The pages are all described in [CHAPTER 8](#).

Help Messages

When you first select the **Help** Button, a number of new buttons appear on the screen, giving you three options:

- Item Help
- Global Help
- Exit from Help.

Item Help

Item Help Buttons appear next to individual fields or objects. Select the button to display a brief message describing the item. Only one help message remains on the screen at a time.

Figure 2.16 Item Help Button



Global Help

The **Global Help** Button appears next to the **Help** Button. If you select the **Global Help** Button, the Page Display Area shows you a description of the current page and all the elements it contains.

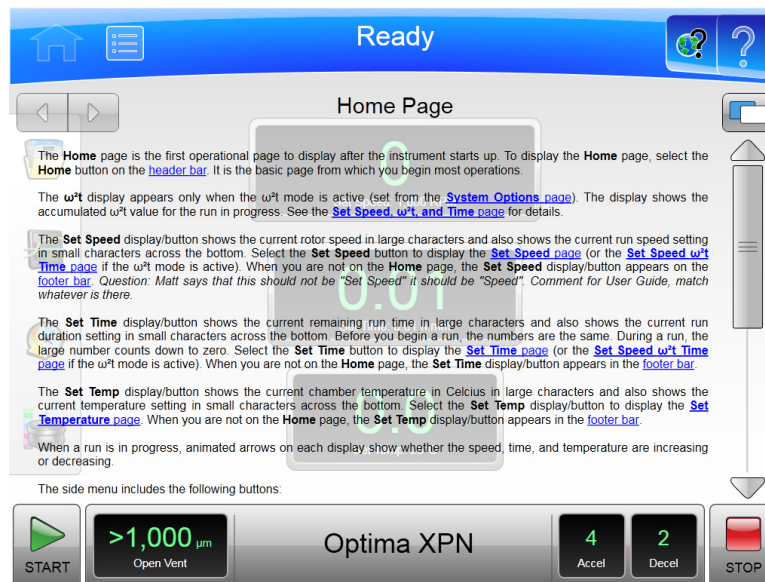
Figure 2.17 Global Help Button attached to Help Button



While using Global Help, you also have some additional options:

- The **Global Help** page appears over a ghost image of the screen you were on when you selected global help.

Figure 2.18 Home Page Help with ghost image



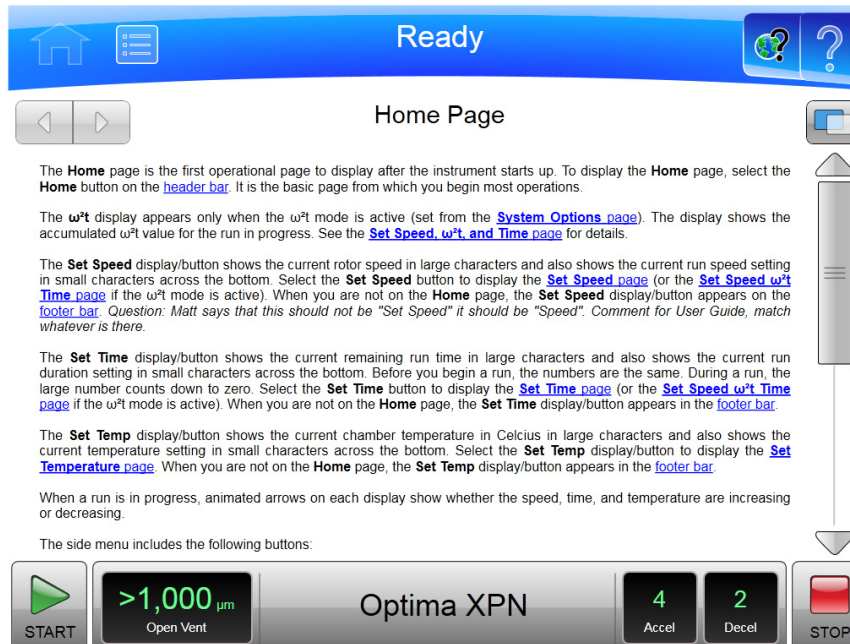
If the ghost image makes it difficult for you to read the **Help** Page, select the **Transparency** Button in the upper right corner.

Figure 2.19 Transparency Button



The resulting opaque help page eliminates the image of the screen behind it.

Figure 2.20 Home Page Help with opaque screen



Select the **Transparency** Button again to return to the ghost screen image.

- If you need information about some other aspect of the instrument, you can select the Table of Contents link at the bottom of the page to see the outline of all the available help pages. You have access to all of the help pages from the Table of Contents.

Figure 2.21 Help Navigation Buttons



- To navigate through your selected help pages, use the **Forward** and **Back** buttons in the upper left corner.

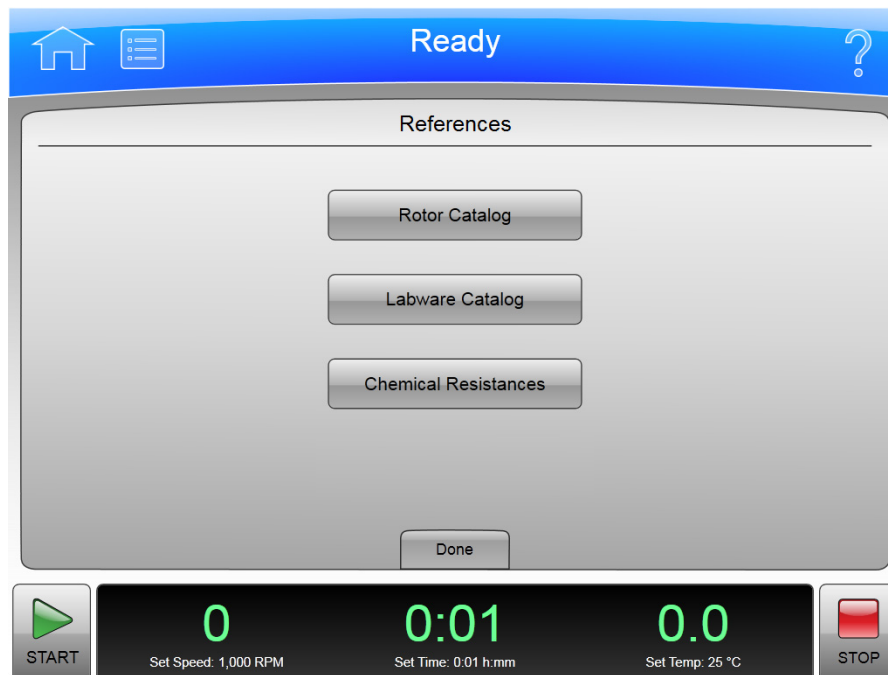
System References

The XPN system includes reference materials you may need as you operate the system:

- The [Rotor Catalog Page](#) lists detailed specifications for rotors that can be used with the XPN.
- The [Labware Catalog Page](#) lists detailed specifications for labware that can be used with approved rotors.
- The [Chemical Resistances Page](#) lists chemical interaction between equipment and accessories used in ultracentrifugation and various commonly used chemicals.

Follow this procedure to display the References page:

Figure 2.22 References Page

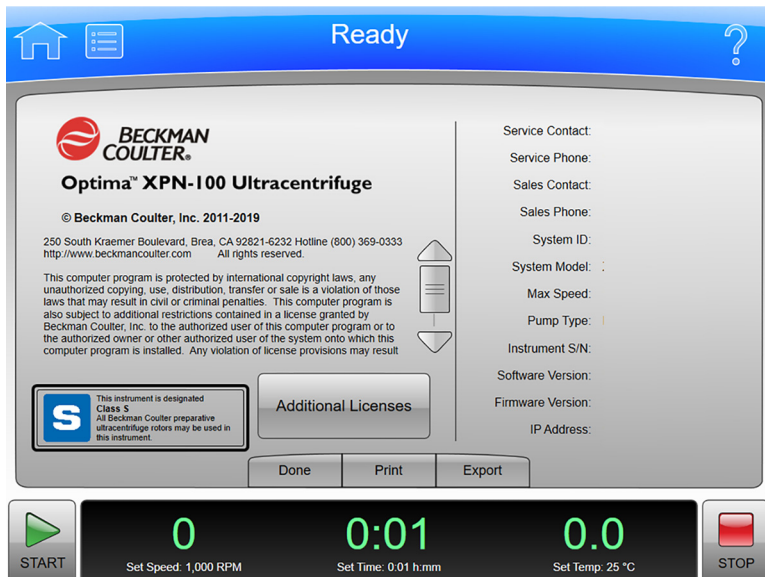


- 1 Select the **Menu** button on the header bar to display the **Menu** page.
- 2 Select the **References** button to display the **References** page.

About Your Instrument

The system About page contains information about your instrument, including the model number, serial number, and software version, that you need when you call Beckman Coulter Field Service. Follow this procedure to display the [About Page](#).

Figure 2.23 About Page



- 1 Select the **Menu** button on the header bar to display the **Menu** page.
- 2 Select the **About** button to display the **About** page.

CHAPTER 3

Operations

The touch screen interface for the Optima XPN simplifies operations. Although there are many additional things you can do, this chapter outlines basic operations:

- Manual Operation
- Operations with Preconditioning
- Continuous Flow Operation
- Zonal Operation

Manual Operation

Manual operation is a simple procedure you can do from the **Home** Page.

Before you begin, you must know:

- If rotor selection is required, which rotor you are using for the run.
- Acceleration and deceleration rate
- Run speed
- Length of time for the run
- Run temperature

NOTE Your system may have additional requirements, depending on your configuration.

When you have this information, the procedure for the run is as follows:

-
- 1** Start on the **Home** Page.

 - 2** Set the speed and rotor.

 - 3** Set the Acceleration and Deceleration Profiles.

 - 4** Set the time.

 - 5** Set the temperature.

6 Start the run.

NOTE When power is restored to the unit, the run parameters will default to the previously used values.

Step 1: Start on the Home Page

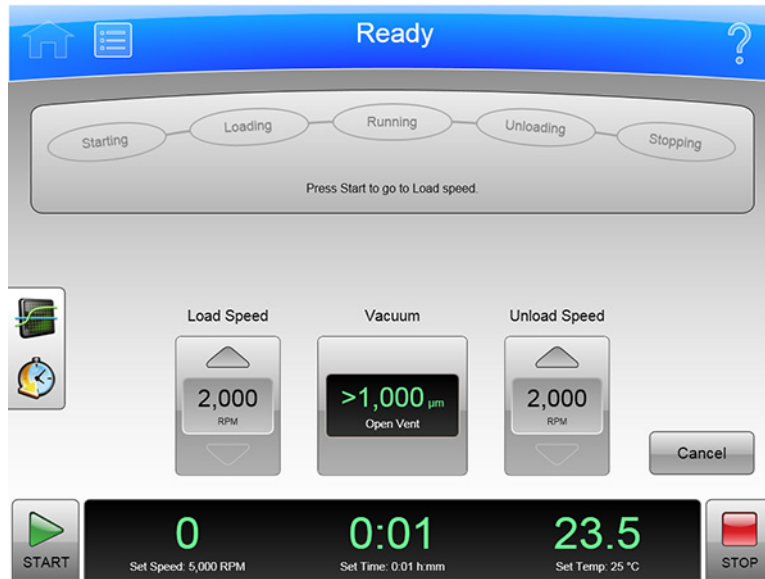
Start at the **Home** Page. If your screen shows any other page, select the **Home Page** Button in the upper left corner of the screen.

Figure 3.1 Home Page



NOTE If your system is in Zonal Mode or Continuous Flow Mode, you must select the **Cancel** Button to go to the Home Page.

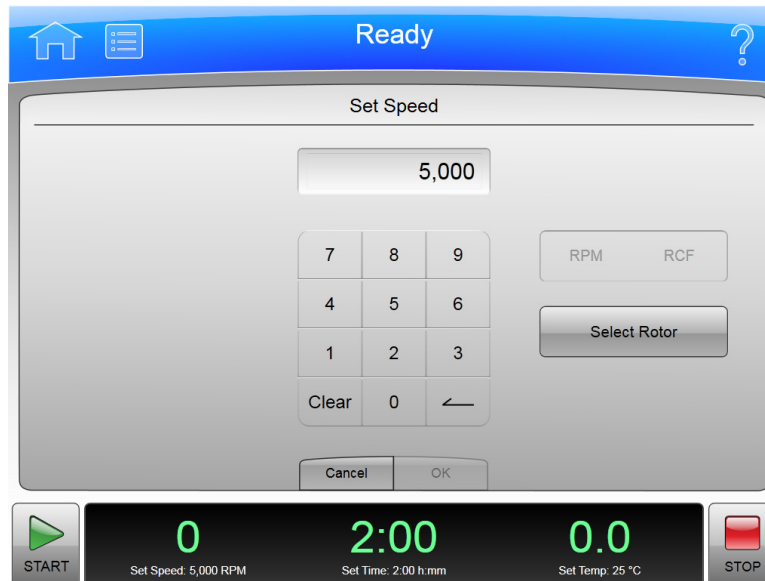
Figure 3.2 Zonal Operation Page with Cancel Button



Step 2: Set the Speed and Rotor

Select the **Set Speed** Display/Button on the **Home** Page to go to the **Set Speed** Page.

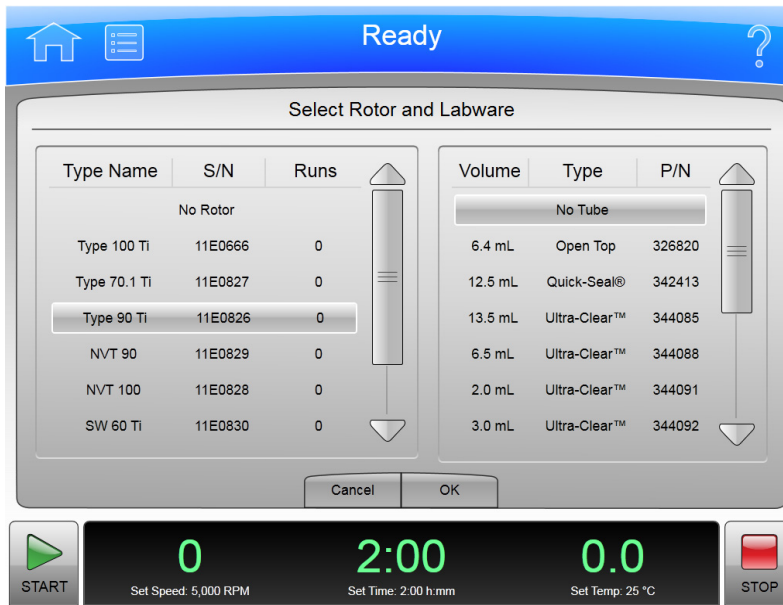
Figure 3.3 Set Speed Page



When the **Set Speed** Page appears, follow these steps:

- 1 If you need to record rotor selection, select the **Select Rotor** Button to go to the **Select Rotor and Labware** Page.

Figure 3.4 Select Rotor and Labware Page



- 2 Select the rotor and labware for the run from the library. If the desired rotor is not in the library, a system Administrator or Super User must add it.
- 3 Select the **OK** Button to return to the **Set Speed** Page.
- 4 If you plan to set the speed in units of relative centrifugal field (RCF), select the **RPM/RCF** Button. Note that the RPM/RCF button is only enabled when you have selected a rotor.
- 5 Use the keypad to set the desired speed. Note that you actually enter hundreds, with two ending zeroes added to your number. You can also use the **Back** and **Clear** keys to make corrections.
- 6 Select the **OK** key to accept your entry and dismiss the page.

Step 3: Set the Acceleration and Deceleration Profiles

Select the **Accel and Decel** Display/Button to go to the **Set Acceleration/Deceleration Profiles** Page.

Figure 3.5 Set Acceleration/Deceleration Profiles Page



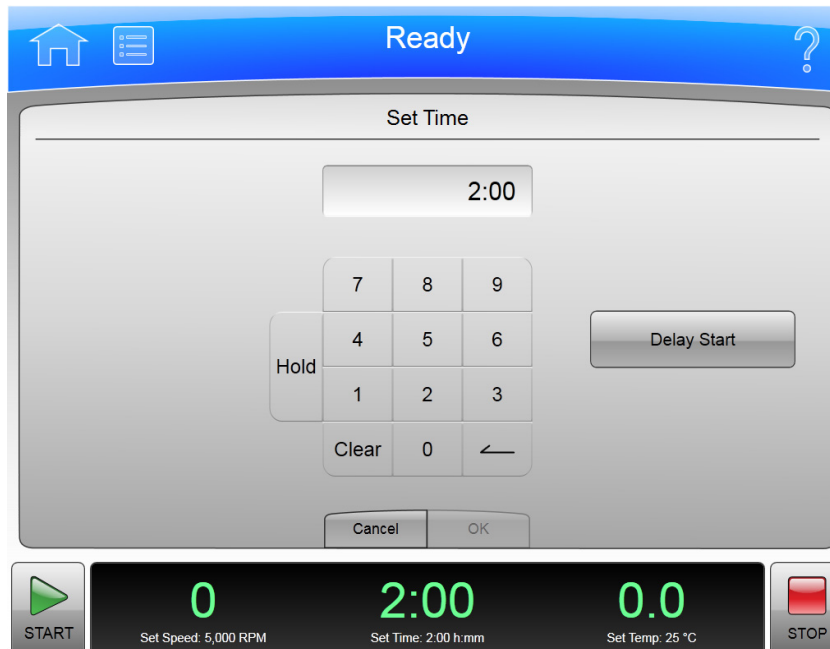
On the **Set Acceleration/Deceleration Profiles** Page, follow these steps:

- 1 Select the desired Acceleration and Deceleration profiles.
- 2 Select the **OK** key to accept your entries and dismiss the page.

Step 4: Set the Time

Select the **Set Time** Display/Button to go to the **Set Time** Page.

Figure 3.6 Set Time Page



On the **Set Time** Page, follow these steps:

- 1 Use the keypad to set the desired time in hours and minutes. Use the **Back** and **Clear** keys to make corrections. You can also use the **Hold** key to set the time to a hold state with no countdown to an automatic end. When you select **Hold**, the run does not end until you select the **Stop** key (or until the maximum time of 999 hours and 59 minutes has been reached).
- 2 You can use the **Delay Start** button to set a future start or stop time. Select **Delay Start** to display the Delay Start Page.

Figure 3.7 Delay Start Page



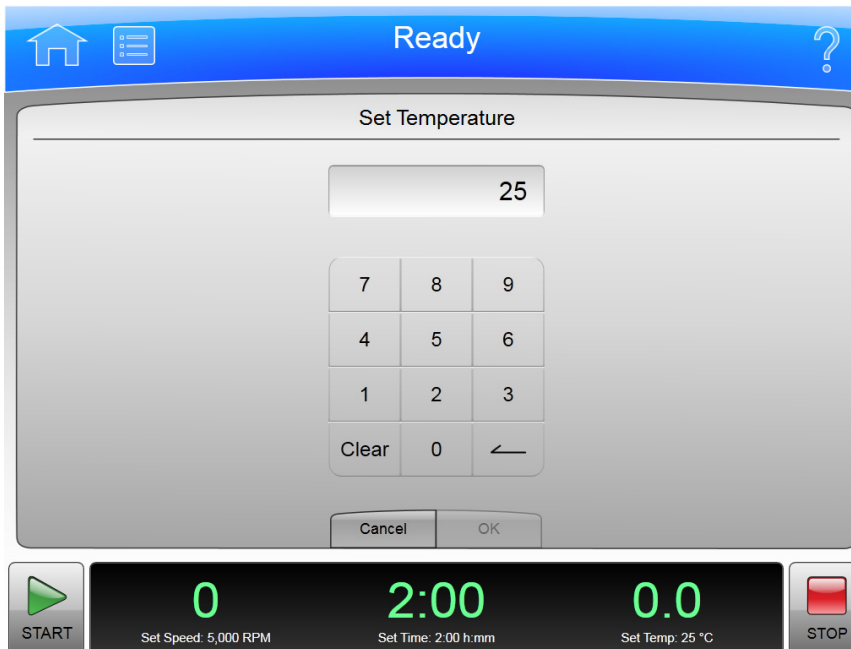
- Select **Start At** or **Stop At** to set a starting or stopping time. Then you can set the date and time in the fields above. Select OK to return to the **Set Time** Page.

3 Select the **OK** key to accept your entry and dismiss the page.

Step 5: Set the Temperature

Select the **Set Temp** Display/Button to go to the **Set Temperature** Page.

Figure 3.8 Set Temperature Page



On the **Set Temperature** Page, follow two steps:

- 1 Use the keypad to set the desired temperature in degrees Celsius. Use the **Back** and **Clear** keys to make corrections.
- 2 Select the **OK** key to accept your entry and dismiss the page.

Step 6: Start the Run

Once the run values are set, start the run:

NOTE If you have entered a delayed start, you must select the Start button to begin the countdown to the delayed start.

-
- 1 Prepare your samples and place them in the rotor following all proper procedures, including balanced weight distribution.

 - 2 Preheat or precool the rotor and samples, if necessary.

 - 3 Mount the rotor in the instrument following all the procedures in the rotor manual and observing all safety procedures and cautions.

 - 4 Close and lock the chamber door. For preconditioning, select the Vacuum Display/Button and wait until the chamber reaches the set temperature.

 - 5 Select the **Start** button.
-

Figure 3.9 Start Button



When the run begins, wait for the countdown timer to reach zero and the rotor to come to a stop. You can then remove your rotor and samples.

Zonal and Continuous Flow Operation

WARNING

In zonal and continuous flow operation, the operator is unavoidably exposed to rotating machinery. For safety, the operator must be properly instructed and qualified. Guard against accidentally dropping objects, such as pens, pencils, or hemostats into the chamber. Loose lab coats, neckties, scarves, and long necklaces should not be worn while operating in the zonal or continuous flow mode.

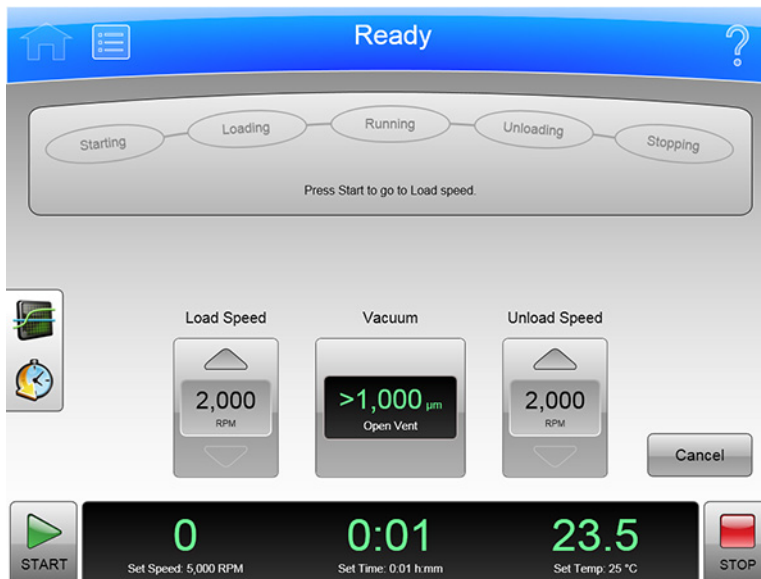
Use only zonal rotors in the zonal mode.

Use only continuous flow rotors in the continuous flow mode.

Zonal and Continuous Flow operations require special rotors and have some additional hazards in that samples are loaded and unloaded while the rotor is spinning. To prevent unauthorized users from attempting these operations, the instrument requires an authorization code (which is 1793). When Zonal or Continuous Flow operations are authorized, the system displays the **Zonal Operation** Page or the **Continuous Flow Operation** Page. While in Zonal or Continuous Flow operation, the **Home** Page button displays the corresponding Zonal or Continuous Flow Operation page. The mode does not end until the run is complete or the user selects the **Cancel** Button to end the mode.

Zonal and Continuous Flow operations are very similar. The specific details vary according to the rotor you are using, but the summary below shows an outline of the procedure.

Figure 3.10 Zonal Page



There are seven phases to a Zonal or Continuous Flow run:

- Preparing
- Starting
- Loading

- Running
- Unloading
- Stopping
- Finishing

Each phase is outlined in a section below.

Preparing for the Run

The rotor manual details the preparations for a run, which may include cleaning, assembling, and lubricating the rotor, setting up pumps and tubing, and usually includes overnight cooling to precondition the rotor, sample and solutions used in the run. When you are ready to install the rotor, set the parameters for the run:

- Run Speed
- Run Time
- Temperature
- Load Speed
- Unload Speed

For Continuous Flow operation, you may have two different load speed settings. The initial setting is for alignment and adjustment checks, which you set in this phase.

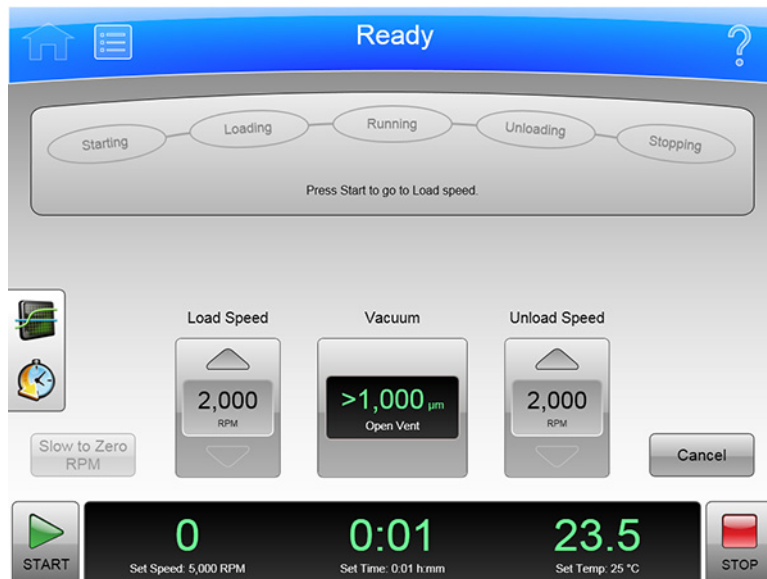
When everything else is ready, mount the rotor and select the **Vacuum** Display/Button to begin preconditioning the chamber. When the chamber reaches the set temperature, you are ready to start the run.

Starting the Run

To start the run, select the **Start** Button and wait for the rotor to reach loading speed. The status display at the top of the screen highlights Starting.

For a Continuous Flow run, you need to perform alignment and adjustment checks as detailed in the rotor manual. You may need to use the **Slow to Zero RPM** button to make adjustments and restart with the **Start** Button. Refer to [Figure 3.11](#). When the rotor passes the alignment and adjustment checks, set the new loading speed (if it is different from the adjustment speed) and select the **Start** Button again.

Figure 3.11 Continuous Flow Page



When the rotor reaches the Loading speed, the status display highlights Loading, to show that you have moved into the next phase.

Loading the Sample

In the Loading phase, you inject the sample into the medium in the rotor. Again, the details depend on the rotor and the type of operation as detailed in the rotor manual. When you have finished all the specified loading steps, close the door and select the **To Running** button to go to the next phase.

Running the Sample

The instrument highlights Running on the Status Display, accelerates to the set run speed, and begins counting down the set run time. The run phase ends in one of three ways:

- When the timer countdown reaches zero, the instrument decelerates to the unloading speed and goes to the Unloading phase.
- If you select the **To Unloading** Button to terminate the run early, the instrument decelerates to the unloading speed and goes to the Unloading phase.
- If you select the **Stop** Button to abort the run, the instrument brings the rotor to a halt, skips the unloading phase, and exits Zonal or Continuous Flow mode entirely.

Unloading the Sample

While the rotor is running at unload speed, follow the instructions in the rotor manual to inject the displacement solution into the rotor and collect the resulting centrifugate sample.

If you need to return to the Running phase for any reason, press the To Running button and the instrument will accelerate the rotor to the Run Speed. The instrument will remain in the Running phase until it is ended in one of the ways discussed in [Running the Sample](#).

Stopping the Run

When you have completed all the defined unloading steps, select the **Stop** Button to bring the rotor to a halt.

Finishing the Run

When the rotor comes to a halt, unmount it and perform all the cleanup and follow-up steps given in the rotor manual. The instrument exits Zonal or Continuous Flow mode when the rotor comes to a stop.

Operations

Zonal and Continuous Flow Operation

The Optima XPN includes the many options for configuring your system. Some of these options have a significant effect on system functionality, and must be configured before you begin to use the system. These options include:

- [Managing Your Network](#)
- [Managing Users](#)
- [Managing Rotors](#)
- [Managing Reports](#)
- [Managing Qualifications](#)

Managing Your Network

You can add the Optima XPN to your network, enabling email, file transfer, and printing to a network printer. You can also enable VNC (Virtual Network Connection) or API (Application Programming Interface) to allow the system to receive instructions from a remote application.

Some features of this instrument can support a GMP workflow with the proper network. Refer to *Optima XPN Series and Avanti JXN Series Recommended Networking Configurations Guide (C67730)* for details. Consult with your local IT department to ensure that privacy and security requirements are met.

Setting Up the Network

- 1** Select the **Menu** button on the Header Bar to display the **Menu** page.
- 2** Select **Options** to display the **System Options** page.
- 3** Select the **Network** Tab, then select **Setup Network** to display the **Setup Network** page.
- 4** **Network path** is the path the instrument automatically uses for import and export. Select the **Network Path** field to display the Export Path page and enter the default path. Select **OK** to return to the Setup Network page.
- 5** **DHCP Mode** (Dynamic Host Configuration Protocol) is enabled by default and automatically configures the IP addressing parameters using a DHCP Server on the network.

If your network administrator provides a specific IP address, disable DHCP mode and enter the values provided for the following fields:

- IP Address
- Subnet Mask
- Default Gateway
- DNS Server

To disable DHCP Mode, select **Enable** so that the green square is cleared.

-
- 6 Select **Save** to save the network information and return to the **System Options** page.
-

Selecting a Printer

Use this option to select a USB or network printer for the instrument. The system automatically sends all print requests to the selected printer.

NOTE Printer drivers must be installed by a Beckman Coulter Field Service representative.

-
- 1 Select the **Menu** Button on the Header Bar to display the **Menu** page.
-
- 2 Select **Options** to display the **System Options** page.
-
- 3 Select the **Network** Tab, then select **Select Printer** to display the **Select Printer** page, which lists the available printers.
-
- 4 Select a printer from the list. You can select **Test Print** to send a test page to the printer.
-
- 5 Select **Save** to save the printer selection and return to the **System Options** page.
-

Setting Up Email

Use this option to configure email that can be sent from the instrument. The instrument will send diagnostic notifications to the email account of all users with an email address entered in their user profile.

-
- 1 Select the **Menu** button on the Header Bar to display the **Menu** page.

-
- 2 Select **Options** to display the **System Options** page.

 - 3 Select the **Network** Tab, then select **Setup Email** to display the **Setup Email** page.

 - 4 Select **SMTP Server** to enter your email server address. Select **OK** to save the address and return to the **Setup Email** page.

 - 5 **Port Number** defaults to 25. Do not change it unless you must use another, specific port number.

 - 6 **User Name** and **Password** are optional, but may be required by your email server. Select the fields to enter the required values, then select **OK** to return to the **Setup Email** page.

 - 7 **Email From** defines the return email address that appears on email notifications sent by the instrument. You can change the default to a legitimate or fictitious address, depending on your requirements. Select the field to enter the new address, then select **OK** to save the address and return to the **Setup Email** page.

 - 8 Select the SSL Server **Enable** button to enable email encryption, if required by your email server. The button displays a green square when the option is enabled.

 - 9 You can select **Test Email** to send an email to test your configuration. Enter the recipient email address and select **OK** to send the email and return to the **Setup Email** page. The system displays a status message for the success or failure sending the test email.

 - 10 When you have completed your configuration, select **Save** to return to the **System Options** page.
-

Setting Up VNC

Use VNC (Virtual Network Connection) to connect to the instrument from a laptop or other remote device.

-
- 1 Select the **Menu** Button on the Header Bar to display the **Menu** page.

 - 2 Select **Options** to display the **System Options** page.

- 3 Select the **Network** Tab, then select **Setup VNC** to display the **Setup VNC** page.
- 4 Select the Enable or Disable VNC Server **Enable** button to enable the VNC server. The button displays a green square when the option is enabled.
- 5 To use the PIN of the current user as the VNC password, select the Synchronize VNC Password To Logged in User PIN **Enable** button. To enter a separate VNC password, select **Set Password**. Enter and confirm the password and select **OK** to save and return to the **Setup VNC** page.
- 6 Select **Back** to return to the **System Options** page.

Enabling API

Use this option to allow a remote device to connect to the instrument using the API.

- 1 Select the **Menu** Button on the Header Bar to display the **Menu** page.
- 2 Select **Options** to display the **System Options** page.
- 3 Select the **Network** Tab, then select **Enable API**. The button displays a green square when the option is enabled.
- 4 Select **Done** to return to the **Home** page.

Setting Up a GMP Network

Some features of this instrument can support a GMP workflow. Refer to *Optima XPN Series and Avanti JXN Series Recommended Networking Configurations Guide* (PN C67730) for details. Consult with your local IT department to ensure that privacy and security requirements are met.

Managing Users

You can require users to log in prior to using the Optima XPN. You can use the login to build a run log for each user, and to control access to the system.

The system includes three user levels that grant different ranges of system access.

Table 4.1 User Levels

| User Level | Permission |
|---------------|--|
| Operator | Can run assigned programs and change user options. |
| Super User | Can run all programs, run the XPN manually, manage users, assign programs, manage the rotor library, perform calculations and simulations. |
| Administrator | Unlimited access. |

Adding Users

- 1 To add users to the system, select the **Menu** Button on the Header Bar to display the **Menu** Page.
- 2 Select **Options** to display the **System Options** Page.
- 3 Select the **Users** Tab, then select **Manage Users** to display the **Manage Users** page.
- 4 Select **Add** to display the **Add User** Page.
- 5 Select the **User ID** field to display the **Edit User ID** Page.
- 6 Use the keypad to enter the new User ID. Select **OK** to return to the **Add User** page.
- 7 Repeat the procedure for the remaining fields. The **PIN** and **Full Name** fields are required.
- 8 Select the User Level. For Operators, you can select the **Authorize Programs** button to add programs to the User. See **Creating Programs** for more information.
- 9 Select **Save** to add the user to the system and return to the **Manage Users** Page.

You can also use the Manage Users page to edit or delete users, to copy existing user information for a new user, or to edit program permissions for Operator-level users.

Requiring Login

- 1 Select the **Menu** Button on the Header Bar to display the **Menu** Page.

-
- 2 Select **Options** to display the **System Options** Page.
-
- 3 Select the **Users** Tab, then select **Require Login**. The button displays a green square when the option is enabled.
-

PIN Expiration and Logout Timer

The system defaults to expire PINs every 60 days, and to log out users after two minutes of inactivity. Follow these steps to change the defaults.

-
- 1 Select the **Menu** Button on the Header Bar to display the **Menu** Page.
-
- 2 Select **Options** to display the **System Options** Page.
-
- 3 Select the **Users** Tab.
-
- 4 To change the PIN expiration, select the **PIN Expiration** button.
-
- 5 Select **Clear** to clear the field. Enter the number of days that you want PINs to remain valid. To disable PIN Expiration, enter 0.
-
- 6 Select **OK** to return to the **Users Tab**.
-
- 7 To change the logout time, select the **Logout Timer** button.
-
- 8 Change the field to the number of minutes of inactivity before the system logs out a user. To disable the Logout Timer, enter 0.
-
- 9 Select **OK** to return to the **Users Tab**.
-

User Options

When Login is required, the User Options page becomes active. From this page, users can change their PIN, add or change their email and phone number, and select an avatar and background to appear on their Home page.

- 1 Select the **Menu** button on the Header Bar to display the **Menu** page.
- 2 Select **Options** to display the **System Options** page.
- 3 Select the **Basic** Tab, then select **User Options**. The system displays the **User Options** page for the user that is currently logged in.
- 4 To change the PIN, select the **PIN** field to display the **Reset User PIN** page.
 - Use the keypad to enter the current PIN, and confirm the new PIN.
 - Select **Save** to change the PIN and return to the **User Options** Page.
- 5 To add or change the email or phone number, select the **Email** or **Phone** field to display the **Edit Email** or **Edit Phone** page.
 - Use the keypad to update the field.
 - Select **Save** to save your changes and return to the **User Options** Page.
- 6 To select or change the avatar or background, select **Set Avatar** or **Set Background** to display the **Select Image** Page.
 - Select an image from the available images on the left, or select **Import Image** to import an image from a USB device or network location.
 - Select **Save** to set the image and return to the **User Options** Page.
- 7 Select an image from the available images on the left, or select **Import Image** to import an image from a USB device or network location.
- 8 Select **Done** to return to the **System Options** page.

Managing Rotors

When you enter a manual run or create a program, you can record the rotor that you are using, and thus track rotor usage and permit conversion from RPM to RCF.

When you enable **Require Rotor Selection**, all users must select a rotor from the rotor library before a run.

To make rotors available for selection, you must add rotors to the rotor library

Adding Rotors

- 1 To add rotors to the rotor library, select the **Menu** button on the Header Bar to display the **Menu** page.
- 2 Select **Options** to display the **System Options** page.
- 3 Select the **System** Tab, then select **Manage Rotors** to display the **Manage Rotors** page.
- 4 Select **Add** to display the **Add to Rotor Library** page.
- 5 Select a type of rotor from the list on the left.
- 6 You must enter a serial number for the rotor. Select the **Serial Number** field to display the **Serial Number** Page. Enter the serial number and select **OK** to return to the **Add to Rotor Library** page.
- 7 If you want to enter an existing run count, repeat the procedure for the **Run Count** field. The run count will increment automatically as the rotor is used.
- 8 Select **Save** to add the rotor to the Rotor Library and return to the **Manage Rotors** Page.

You can also use the Manage Rotors page to delete rotors from the library.

Requiring Rotor Selection

- 1 Select the **Menu** button on the Header Bar to display the **Menu** page.
- 2 Select **Options** to display the **System Options** page.
- 3 Select **Require Rotor Selection**. The button displays a green square when the option is enabled.

Managing Reports

Optima XPN automatically saves run history data associated with each run. The run history generated includes:

- User information
- Start date and time of the run
- End date and time of the run
- Rotor type
- Labware (tube)
- Program name
- Acceleration and Deceleration parameters
- Before Run Comment
- After Run Comment
- Detailed information about each step in a run
- Graph of the run
- Most recent Installation Qualification, Operational Qualification, and Performance Qualification dates
- Optional E-signatures

User Access

- An Operator-level user can manually filter data, graph data, and print data for a run.
- A Super User-level user can also export run history data to an external media source, such as a USB drive or network location.
- An Administrator-level user can also configure Optima XPN to automatically print and/or export run history data.

Filter Data

You can filter run history data before you graph or print it.

-
- 1 On the **Home** page, select the **Run History** button on the side menu.

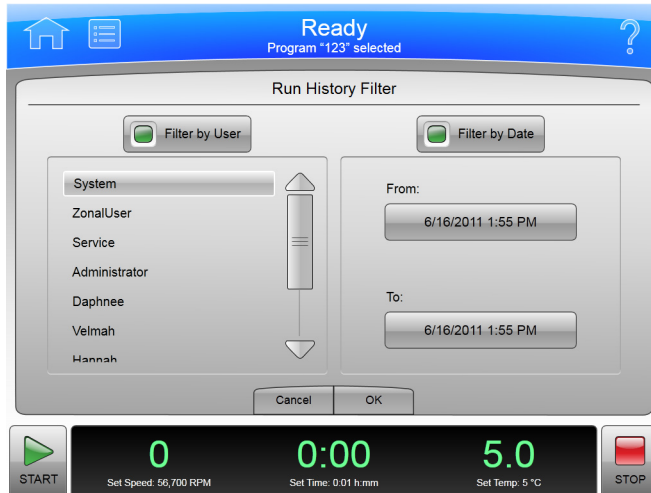
Figure 4.1 Run History Button



-
- 2 On the **Run History** page, select the **Filter** tab at the bottom of the screen.

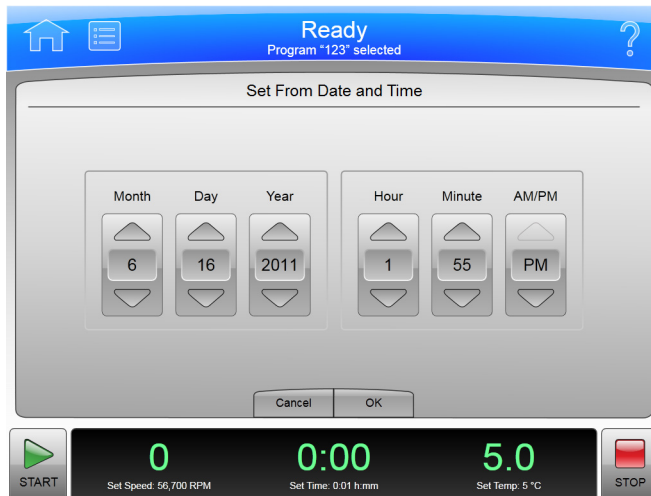
- 3 On the **Run History Filter** page, select the **Filter by User** button and choose from the options below.

Figure 4.2 Run History Filter



- 4 Select the **Filter by Date** button, then select the **From** button.

Figure 4.3 Set From Date and Time

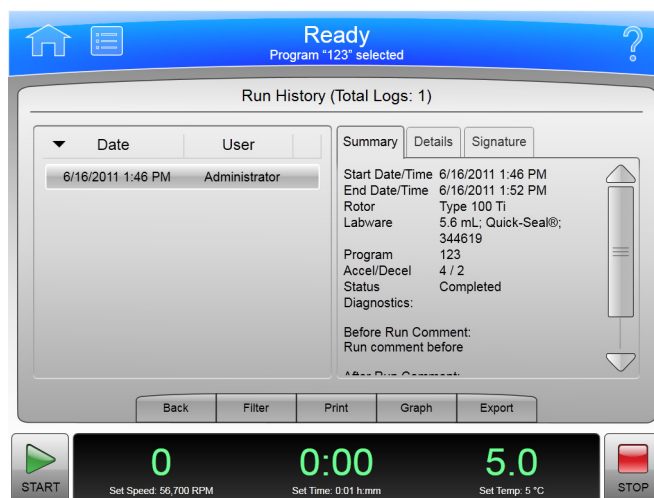


- 5 On the **Set From Date and Time** page, use the up and down arrow buttons to set the parameters for the Month, Day, Year, Hour, Minute, and AM/PM. Then select OK to return to the **Run History Filter** page.

- 6 Select the **To** button under Filter by Date.

- 7 On the **Set To Date and Time** page, again use the up and down arrow buttons to set the parameters for Month, Day, Year, Hour, Minute, and AM/PM (depending on selected time format). Then select OK to return to the **Run History Filter** page.
- 8 On the **Run History Filter** page, select OK to return to the **Run History** page.
You can now Print, Graph or Export the filtered run history.

Figure 4.4 Run History



Graph Data

To graph data for a run in progress:

- 1 Select the **Run Graph** button on the side menu of the **Home** page.

Figure 4.5 Run Graph Button



- 2 On the **Real-Time Run Data** page, select **Options**.

- 3 On the **Run Graph Options** page, select one of three options under Run Graph View Scope: **Fit To Screen**, **Auto Scroll**, or **Manual Scroll**. The default is **Fit To Screen**. Then select **OK**.

To graph data for a previously completed run:

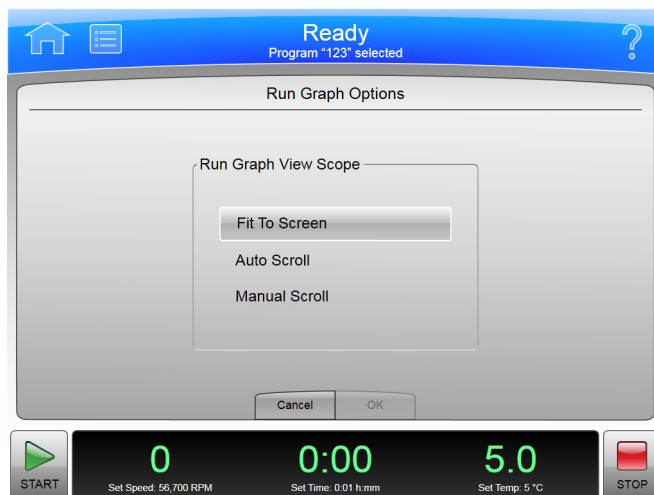
- 1 Select the **Run History** button on the side menu of the **Home** page.

Figure 4.6 Run History Button



- 2 On the **Run History** page, select the Date of the run from the left column.
- 3 Select the **Graph** tab at the bottom of the page.
- 4 On the **Historical Run Data** page, select **Options**.
- 5 On the **Run Graph Options** page, choose one of three options: **Fit To Screen**, **Auto Scroll**, or **Manual Scroll**. (**Fit To Screen** is the default.) Then select **OK**.

Figure 4.7 Run Graph Options



Print Data

You can print run history from the Run Graph page or the Run History page.

NOTE You must have Administrator access to configure the printer.

To print run history from the **Run Graph** page:

- 1 After the run is completed, select the **Run Graph** button from the side menu on the **Home** page.

Figure 4.8 Run Graph Button



- 2 On the **Historical Run Data** page, select the **Options** tab.
- 3 On the **Run Graph Options** page, choose one of three options: **Fit To Screen**, **Auto Scroll**, or **Manual Scroll**. (**Fit To Screen** is the default.) Then select **OK**.
- 4 Select the **Print** button. The system sends the run graph to the printer configured by the Administrator.

To print run history from the **Run History** page:

- 1 Select the **Run History** button from the side menu of the **Home** page.

Figure 4.9 Run History Button



- 2 Use filtering to display the run histories you want to print.
- 3 Select the **Print** button. The system sends the run history for all currently listed runs to the printer configured by the Administrator.

Export Data

Run history data can be manually exported to an external media source, such as a USB drive, or automatically exported to a network. Run history reports are generated in PDF and XML formats, while run history data is in CSV format.

NOTE You must have Administrator access to configure the network to automatically export data.

To manually export run history data to a USB drive:

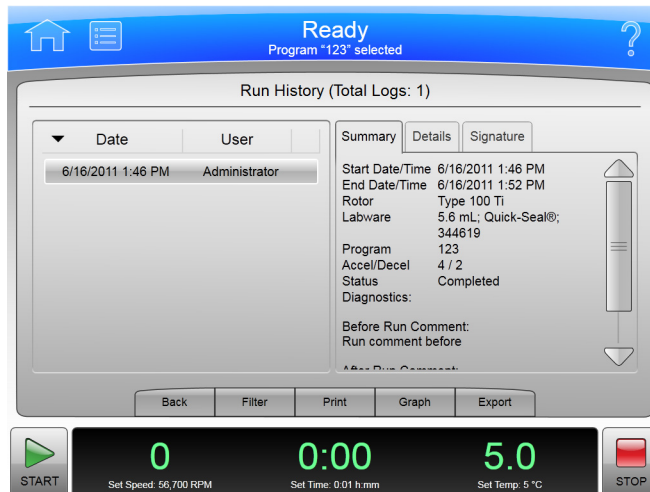
- 1 Select the **Run History** button on the side menu of the **Home** page.

Figure 4.10 Run History Button



- 2 On the **Run History** page (Figure 4.11), use filtering to display the run histories you want to export, then select the **Export** button.

Figure 4.11 Run History



- 3 On the **Export Run History** page, the system displays a prompt to insert the USB drive.
- 4 When the system reads the USB drive, select it from the Available Drives list, and select the **Export** button.
Optima XPN will then export the currently listed run histories to the USB drive.

To manually export run history data to a mapped network:

- 1 Select the **Run History** button on the side menu of the **Home** page.

Figure 4.12 Run History Button



- 2 On the **Run History** page, use filtering to display the run histories you want to export, then select the **Export** button.
- 3 On the **Export Run History** page, select the network from the Available Drives list, then select the **Export** button.

Auto Print and Auto Export Run History Data

A user with Administrator access can configure Optima XPN to automatically print run history data. Optima XPN can also be configured to automatically export run history data to a previously configured network. Run history data automatically sent to a network is generated as a CSV file (a simple spreadsheet format) and an XML file (a simple, structured text format).

IMPORTANT Before you enable Auto Export, check with your network administrator to make sure you have write permission to a folder where the automatically exported run history data can be stored.

To enable Auto Print:

- 1 Select the **Menu** button at the top of the **Home** page.
- 2 Select the **Options** button.
- 3 Select the **Reports** tab.
- 4 Select the **Auto Print** button.

The small box in the **Auto Print** button will turn green to indicate it is enabled.

When a run is completed, Optima XPN will automatically print the run history data to the printer previously configured to the program.

-
- 5** To deactivate the **Auto Print** function, follow the previous four steps.
The small box in the **Auto Print** button will turn grey to indicate it is disabled.
-

To enable Auto Export:

NOTE Before you enable Auto Export, use the Setup Network page to configure network settings. See [Setting Up the Network](#) for more information.

-
- 1** Select the **Menu** button at the top of the **Home** page.
-
- 2** Select the **Options** button.
-
- 3** Select the **Reports** tab.
-
- 4** Select the **Auto Export** button.
The small box in the **Auto Export** button will turn green to indicate it is enabled.
When a run is completed, the instrument automatically exports the run history data to the network (if previously configured to the program) as a CSV file (a simple text spreadsheet) and an XML file (a simple, structured text format).
-
- 5** To deactivate the Auto Export function, follow the previous four steps.
The small box in the **Auto Export** button will turn grey to indicate it is disabled.
-

Run Comments

The Run Comments function enables the user to add comments to the run log before and after the end of a run.

To enable Run Comments:

-
- 1** On the **Home** page, click on **Menu** icon.
-
- 2** Select **Options**.
-
- 3** Select the **Reports** tab.

4 Select the **Run Comments** button.

The small box in the **Run Comments** button will turn green to indicate it is enabled.

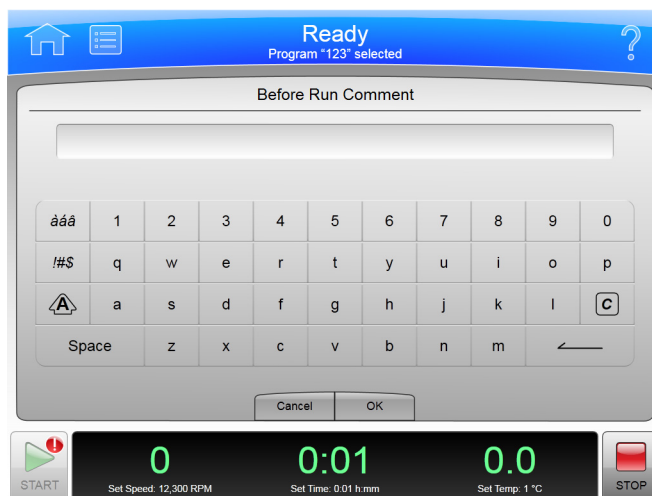
5 To deactivate the Run Comments function, follow the previous four steps.

The small box in the **Run Comments** button will turn grey to indicate it is disabled.

To use Run Comments:

1 Select the **Start** button to begin a run.**2** The system displays the **Before Run Comment** page (Figure 4.13). Enter a comment and select **OK** to start the run. You can leave the comment field blank, but you must select **OK** to start the run. If you select **Cancel**, the run will not start.

Figure 4.13 Before Run Comment

**3** When the run stops or you select the **Stop** button, the system displays the **After Run Comment** page. Enter a comment, and select **OK**.

The comments appear in the **Summary** tab of the **Run History** page.

Signature Options

Manual Signature or E-Signature lines can be added to run history reports to support a GMP workflow. The E-Signature function permits a user to electronically add a signature and add a note (if desired) to run history data after the run is complete.

NOTE You must have Administrator access to select signature options. **Require Login** must be enabled to select a signature option.

To select a signature option:

- 1 On the **Home** page, select the **Menu** button.

- 2 Select the **Options** button.

- 3 Select the **Reports** tab.

- 4 Select the **Signature** drop down box.
Options for **Manual signature**, **E-signature**, or **No signature** are available.

- 5 Select signature lines to include in reports.
 - a. If you select **No Signature**, no signature line will be included in each run history.
 - b. If you select **Manual Signature**, you can select the signatories (**Author**, **Reviewer**, **Approver**) you wish to include in each run history. A box for each selected signature will be included in each run history.
 - c. If you select ESignature, the current user ID can be manually added (Author, Reviewer, Approver) to each run history.
 - d. If you export a run history report, manual signature lines or E-signature lines (if selected) will be included in the report.
 - e. Run history reports will include existing E-signatures, even if E-signatures are not selected at the time of export.

To use E-Signature:

- 1 After a run is complete, select the **Run History** button on the side menu of the Home page.

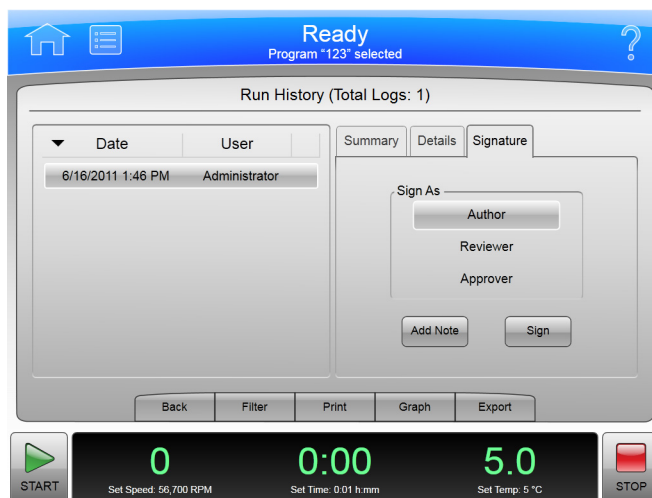
- 2 On the **Run History** page, select the run to which the E-Signature will be added.

- 3 Select the **Signature** tab.

- 4 In the **Sign As** box, select Author, Reviewer, or Approver (Figure 4.14).

NOTE You can select the Author option only if you started the run. You must have Super User or Administrator access to select Reviewer or Approver.

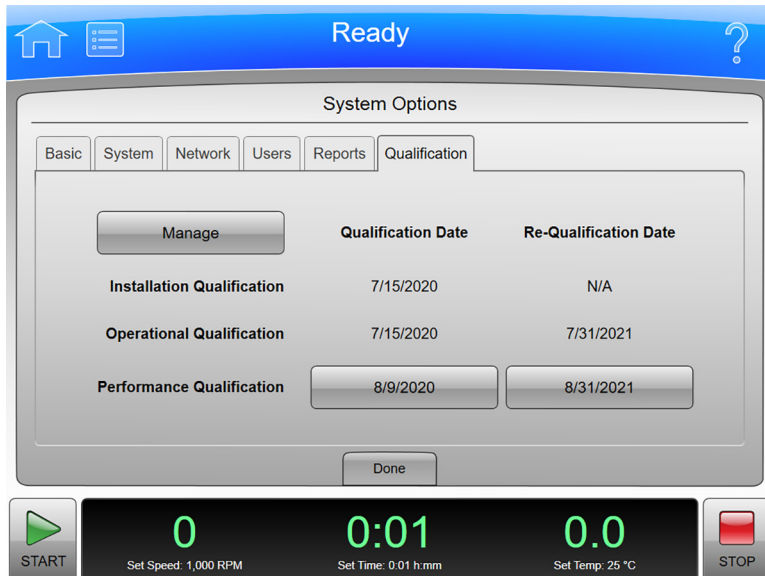
Figure 4.14 Signature



- 5 Select **Sign** or **Add Note**.
- If you select **Sign**, the system displays the **Sign** page. Enter your PIN and select **OK**. The system adds the E-Signature to the Summary on the **Run History** Page. See the [Run History Page](#) for more information.
 - If you select **Add Note**, the system displays the **Add Note** page. Enter the note, then select **Sign**. The system displays the **Sign** page. Enter your PIN and select **OK**. The note and E-Signature will be added to the Summary on the **Run History** page. See the [Run History Page](#) for more information.

Managing Qualifications

Figure 4.15 System Options - Qualification



Optima XPN can provide instrument qualification status and the ability to enable a qualification alert.

- **Installation Qualification (IQ)** - Qualification at installation performed by a BCI Service Technician.
- **Operational Qualification (OQ)** - Certified qualification performed at either 6 or 12 month interval by a BCI Service Technician. [Contact Us](#).
- **Performance Qualification (PQ)** - Workflow verification performed by a user lab at a user-selected interval.

NOTE You must have Administrator access to enter PQ dates and to enable the qualification alert.

- 1 On the **Home** page, select the **Menu** button.
- 2 Select the **Options** button.
- 3 Select the **Qualifications** tab (Figure 4.15).
- 4 Select the **Performance Qualification** button to enter the initial qualification date and time.
- 5 Select the **Performance Re-qualification** button to enter the re-qualification date and time.

Figure 4.16 Qualification Management



- 6 Select the **Manage** button to display the **Qualification Management** page (Figure 4.16).
- 7 Select the **Enable Alerts** button. The small box in the **Enable Alerts** button will turn green to indicate that it is enabled. A Qualification Alert icon will be displayed at the top of the screen within 30 days of the re-qualification date and will continue to be displayed after the date. The instrument continues to function normally when the Alert icon is displayed. Selecting the **Alert** icon will immediately open the Qualification tab.
- 8 Select the desired **Operational Qualification Time Interval**.

The Optima XPN includes the functionality to create and store programs in the centrifuge memory. A program is a series of steps containing parameters for a run. Programs are retained in the centrifuge memory until they are deleted.

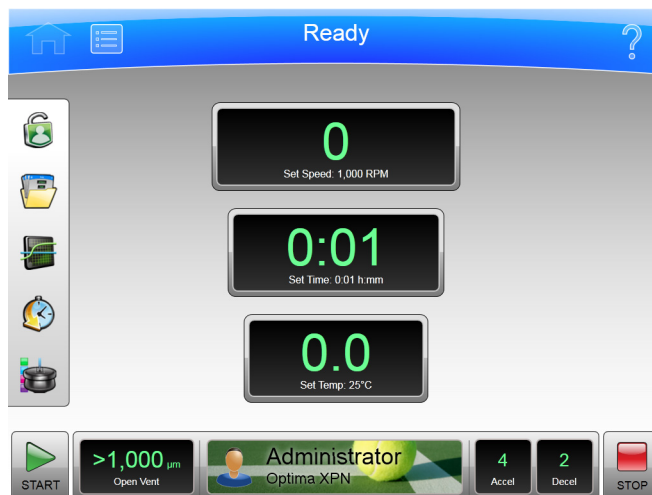
Creating Programs

- 1 Select **Program** from the side menu on the **Home** page.

Figure 5.1 Program Button

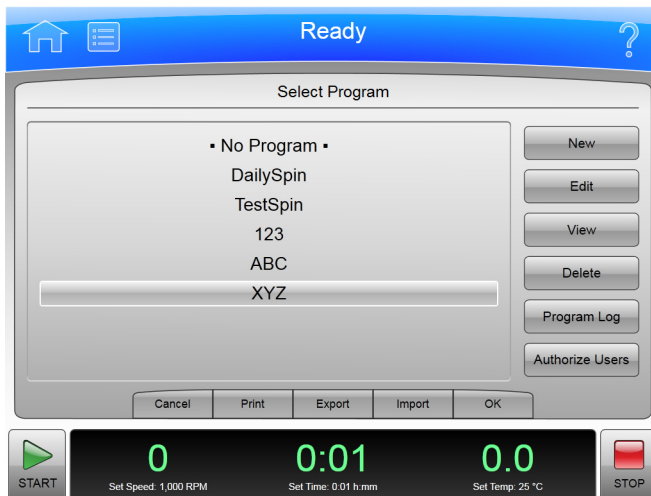


Figure 5.2 Home



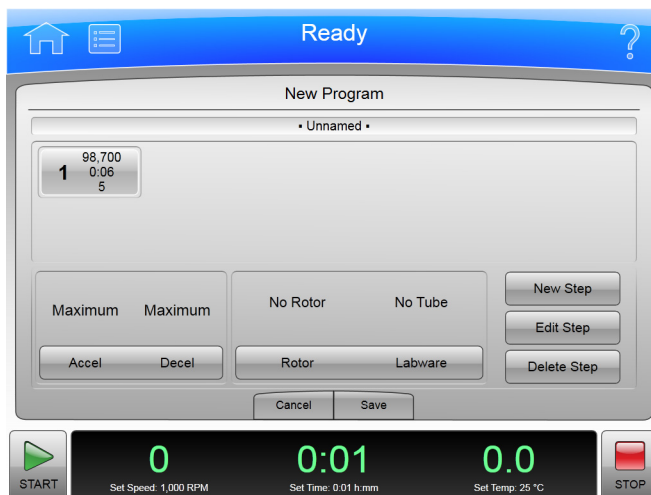
- 2 On the **Select Program** page, select the **New** button.

Figure 5.3 Select Program



- 3 On the **New Program** page, **•Unnamed•** appears as the title. To name the new program now, select **•Unnamed•** on the screen.

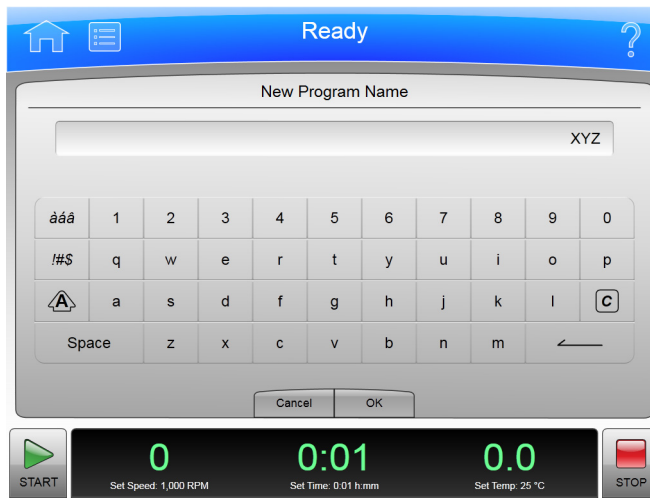
Figure 5.4 Unnamed program



- 4 On the **New Program Name** page, use the keyboard to name it, then select **OK** to save it.

NOTE Program names cannot be reused.

Figure 5.5 New Program Name



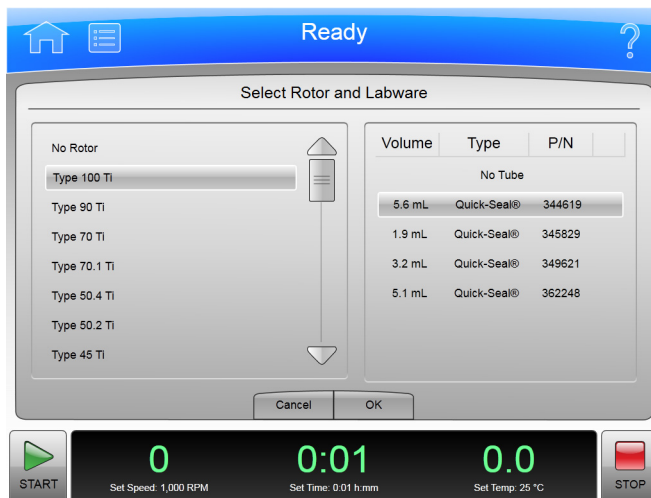
- 5 On the **New Program** page, select the **Accel Decel** button to set the Acceleration and Deceleration profiles. On the **Acceleration/Deceleration Profiles** page, set the profiles, then select **OK** to save them and return to the previous page.

Figure 5.6 Set Acceleration/Deceleration Profiles



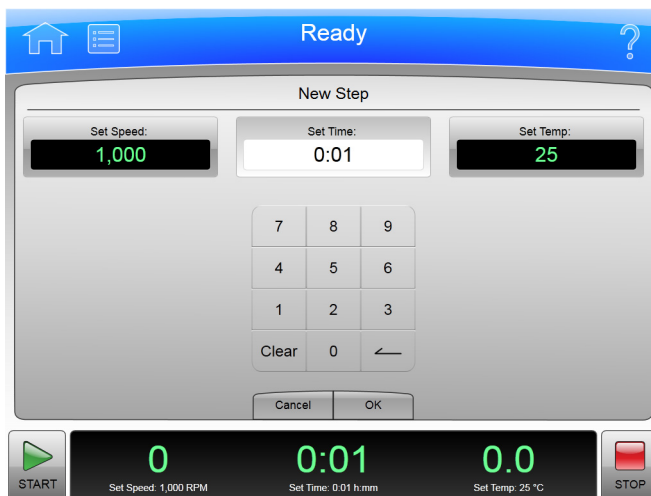
- 6 To specify the rotor and labware, select the **Rotor Labware** button. The system displays rotor types on the left side of the page. Select a rotor, then select the compatible labware from the list on the right side of the page. When you are finished making your selections, select **OK** to save them and return to the previous page.

Figure 5.7 Select Rotor and Labware



7 On the **New Program** page, select the **New Step** button.

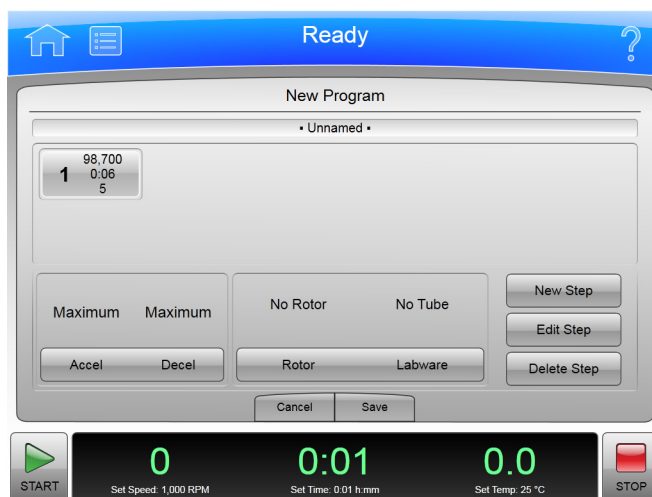
Figure 5.8 New Step



- Select the **Set Speed** button at the top of the page, then use the keypad to set the speed. The speed must be at least 1,000 RPM up to the maximum speed for selected rotor and labware, or if no rotor is specified, the rated speed for the instrument.
- Select the **Set Time** button, then use the keypad to set the time range. The run time must be between 1 minute and 999 hours 59 minutes.
- Select the **Set Temp** button, then use the keypad to set the temperature.
- When the parameters for Speed, Time, and Temperature are set, select **OK** to save the step and return to the **New Program** page.

- 8 The new step appears in a numbered sequence for the run. From this point, more steps can be added to the run, edited, or deleted using the **New Step**, **Edit Step**, and **Delete Step** buttons.

Figure 5.9 New Step in a numbered sequence



Running Programs

- 1 Select **Program** from the side menu on the **Home** page.

Figure 5.10 Program Button



- 2 On the **Select Program** page, choose the program you want to run, then select **OK**.
- 3 Select the **Start** button. The run program begins.

NOTE You must have Super User or Administrator access to change a run in progress. If you select the Set Speed, Set Time, or Set Temp buttons to change the parameters while a program is running, the system displays a message that you cannot change parameter values for the selected program. It will ask if you want to exit the program and run with the changes, in which case, the remaining steps in the program will NOT be run.

- 4 To stop the run for any reason, select the **Stop** button.

Editing Programs

You must have Administrator or Super User access to modify any part of a program, which includes the Steps, Acceleration/Deceleration rates, and Rotor and Labware. You can edit a program only when it is not running.

To edit a program:

- 1 Select **Program** from the side menu on the **Home** page.

Figure 5.11 Program Button



- 2 Select the program you want to edit and select the **Edit** button. If the program is selected to run, that selection will be cleared. If the program is running, the **Edit** button will be disabled.
- 3 On the **Edit Program** page, select the numbered step you want to edit, then select the **Edit Step** button.
- 4 On the **Edit Step** page, select each button you want to modify (**Set Speed**, **Set Time**, and **Set Temp**), then select the **Clear** button and enter the new parameters. Select **OK** to save the changes and return to the previous page.
- 5 On the **Edit Program** page, you can select the **Accel Decel** button and/or the **Rotor Labware** button, and modify each set of parameters. Then select **Save**.

Deleting Programs

You can delete any program that is not currently running.

- 1 On the **Home** page, select **Program** from the side menu.

Figure 5.12 Program Button



2 On the **Select Program** page, select the program you want to delete, then select the **Delete** button.

3 The system displays a confirmation message. Select **Yes** to delete the program, or select **No** to cancel the deletion.

NOTE A deleted program name cannot be reused.

Using Calculations

Use Calculations to perform a variety of calculations commonly used in ultracentrifugation. These calculations help simplify run preparation.

The Calculations function includes the following options:

- [Reduce Rotor Speed For Dense Solutions](#)
- [Reduce Rotor Speed For Precipitating Solutions](#)
- [Sedimentation Coefficient From Run Data](#)
- [Sedimentation Coefficient From Molecular Mass](#)
- [Pelleting Time](#)
- [Refractive Index](#)
- [Concentration Measures](#)

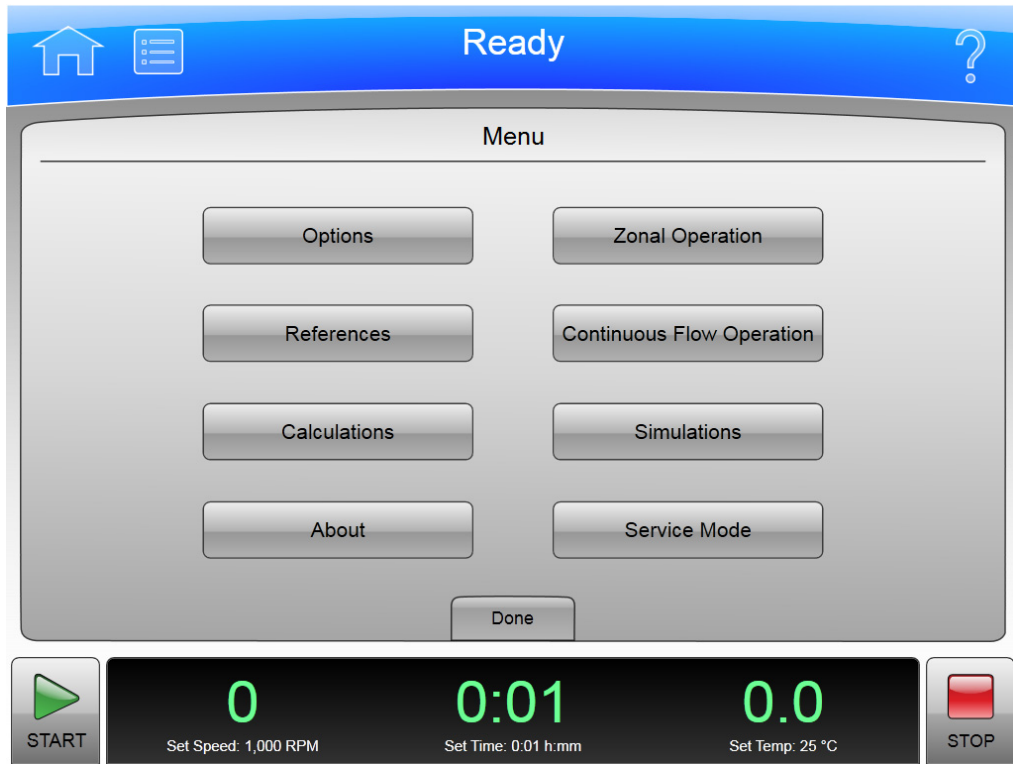
The following sections describe how to access the Calculations Page and use the options.

Calculations Page

To display the Calculations page:

-
- 1 On the **Menu** Page, select **Calculations**.

Figure 6.1 Menu Page



The system displays the Calculations page.

Figure 6.2 Calculations Page



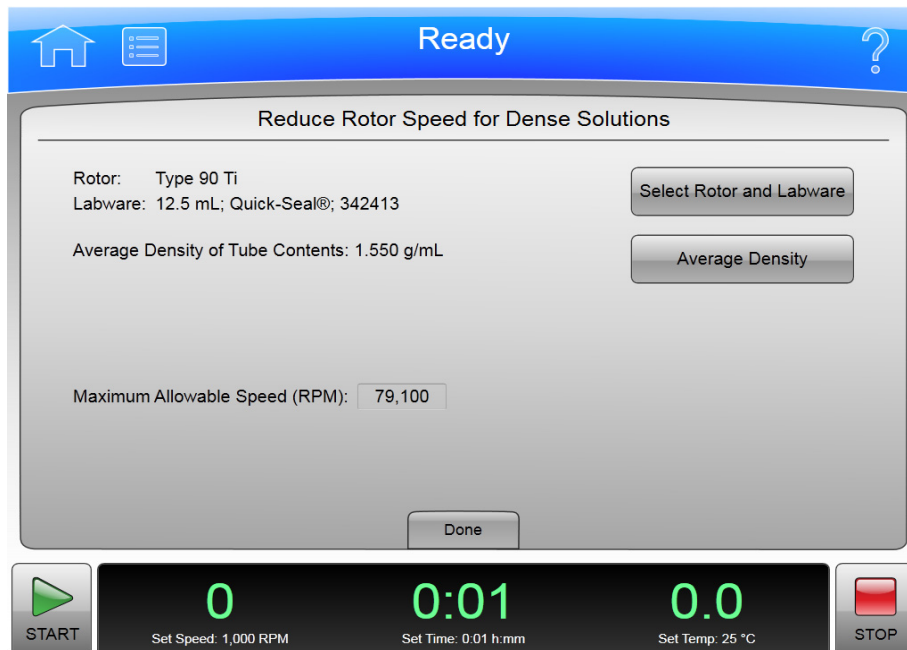
Reduce Rotor Speed For Dense Solutions

This function calculates the reduced run speed when centrifuging a solution with a density greater than the allowable density rating of the rotor (as listed in the applicable rotor manual) to protect the rotor from excessive stresses due to the added load.

To calculate the reduced speed for dense solutions:

- 1 On the Calculations page, select **Reduce Rotor Speed For Dense Solutions**.
The system displays the Reduce Rotor Speed for Dense Solutions page.

Figure 6.3 Reduce Rotor Speed for Dense Solutions Page



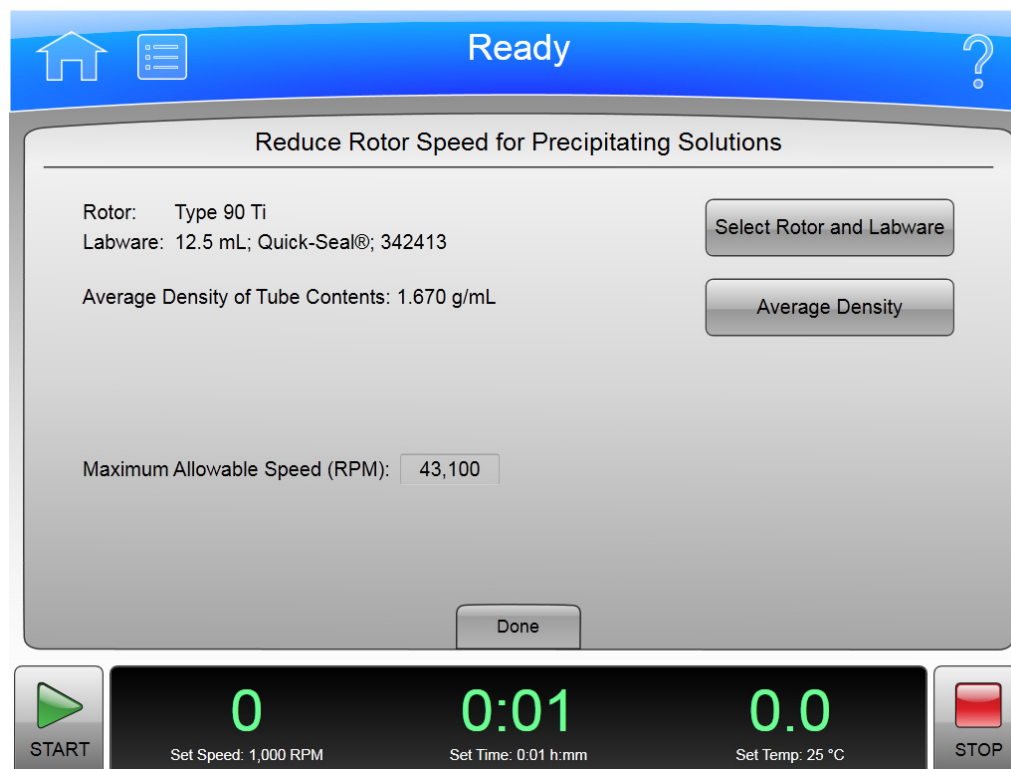
- 2 Select **Select Rotor and Labware** to select a rotor and labware combination, then select **OK**.
- 3 Select **Average Density** to enter the average density of the tube contents in g/mL, then select **OK**.
The **Maximum Allowable Speed (RPM)** is displayed.
- 4 Note the calculated speed, then select **Done** to return to the Calculations page.

Reduce Rotor Speed For Precipitating Solutions

This function calculates the reduced run speed to avoid precipitation of gradient material during centrifugation, based on CsCl at 25°C.

To calculate the reduced speed for precipitating solutions:

- 1 On the Calculations page, select **Reduce Rotor Speed For Precipitating Solutions**.
The system displays the Reduce Rotor Speed for Precipitating Solutions page.

Figure 6.4 Reduce Rotor Speed for Precipitating Solutions Page

- 2 Select **Select Rotor and Labware** to select a rotor and labware combination, then select **OK**.
- 3 Select **Average Density** to enter the average density of the tube contents in g/mL, then select **OK**.
The **Maximum Allowable Speed (RPM)** is displayed.
- 4 Note the calculated speed, then select **Done** to return to the Calculations page.

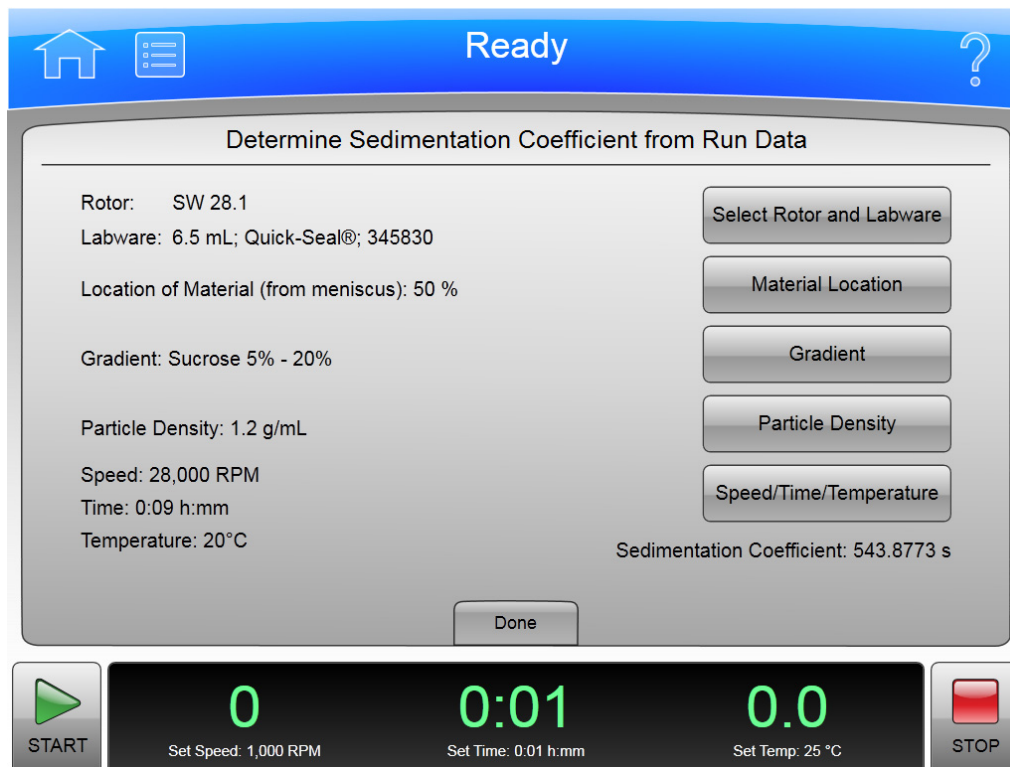
Sedimentation Coefficient From Run Data

This function calculates the sedimentation coefficient from the given run data, based upon a rate zonal run.

To calculate the sedimentation coefficient:

- 1 On the Calculations page, select **Sedimentation Coefficient From Run Data**.
The system displays the Determine Sedimentation Coefficient From Run Data page.

Figure 6.5 Determine Sedimentation Coefficient From Run Data Page



- 2 Select **Select Rotor and Labware** to select a rotor and labware combination, then select **OK**.
- 3 Select **Material Location** to enter the material location as the percentage down the tube from the meniscus, then select **OK**.
- 4 Select **Gradient** to select the gradient, then select **OK**.

Density gradient centrifugation is a technique used to separate proteins of different sizes from a sample. These are the options:

 - Water
 - Sucrose 5% - 20%
 - Sucrose 10% - 40%
 - Sucrose (Custom)

Use the Sucrose (Custom) option to manually select the gradient of your choice. Once the (Custom) option is selected, use the up or down arrow to set the limits, then select **OK**.
- 5 Select **Particle Density** to enter the value for the particle density in g/mL, then select **OK**.

- 6 Select **Speed/Time/Temperature** and enter the values for the speed, time, and temperature, then select **OK**.
- 7 Note the sedimentation coefficient, then select **Done** to return to the Calculations page.

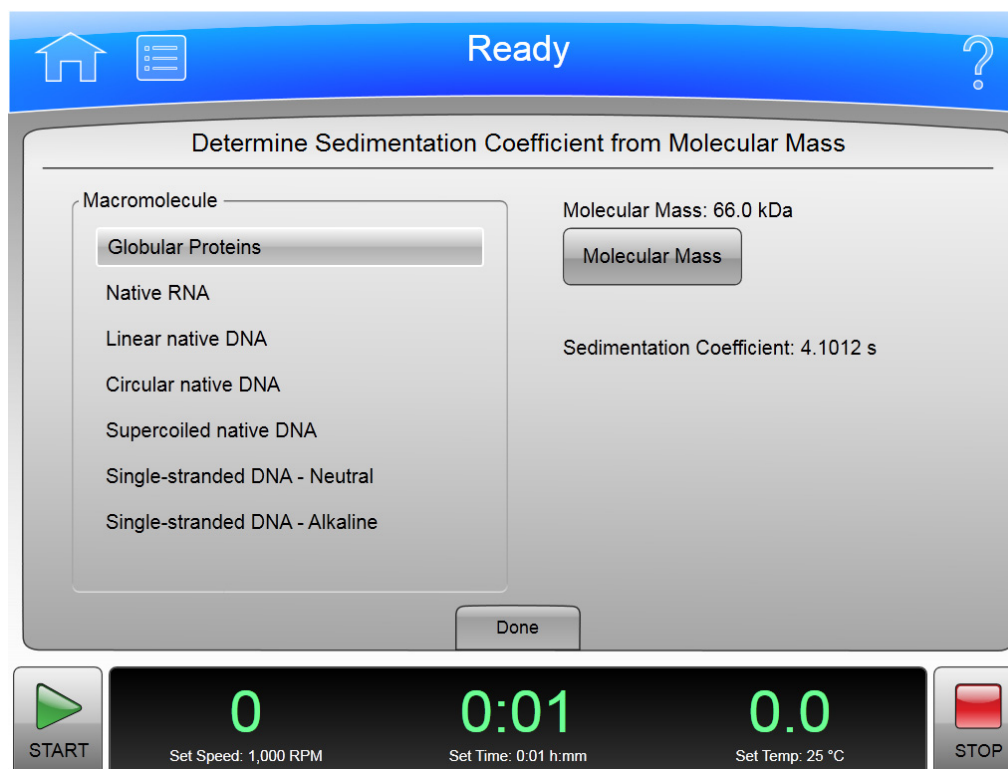
Sedimentation Coefficient From Molecular Mass

This function calculates the sedimentation coefficient from the given molecular weight of the macromolecule.

To calculate the sedimentation coefficient:

- 1 On the Calculations page, select **Sedimentation Coefficient from Molecular Mass**. The system displays the **Determine Sedimentation Coefficient from Molecular Mass** page.

Figure 6.6 Determine Sedimentation Coefficient from Molecular Mass Page



- 2 Select the macromolecule.

- 3 Select **Molecular Mass** or **Molecular Length** to enter the molecular mass or molecular length of the molecule, then select **OK**.

NOTE The **Molecular Mass** button changes to **Molecular Length** for the DNA or RNA macromolecules. The **Sedimentation Coefficient** is displayed.

- 4 Note the calculated sedimentation coefficient, then select **Done** to return to the Calculations page.

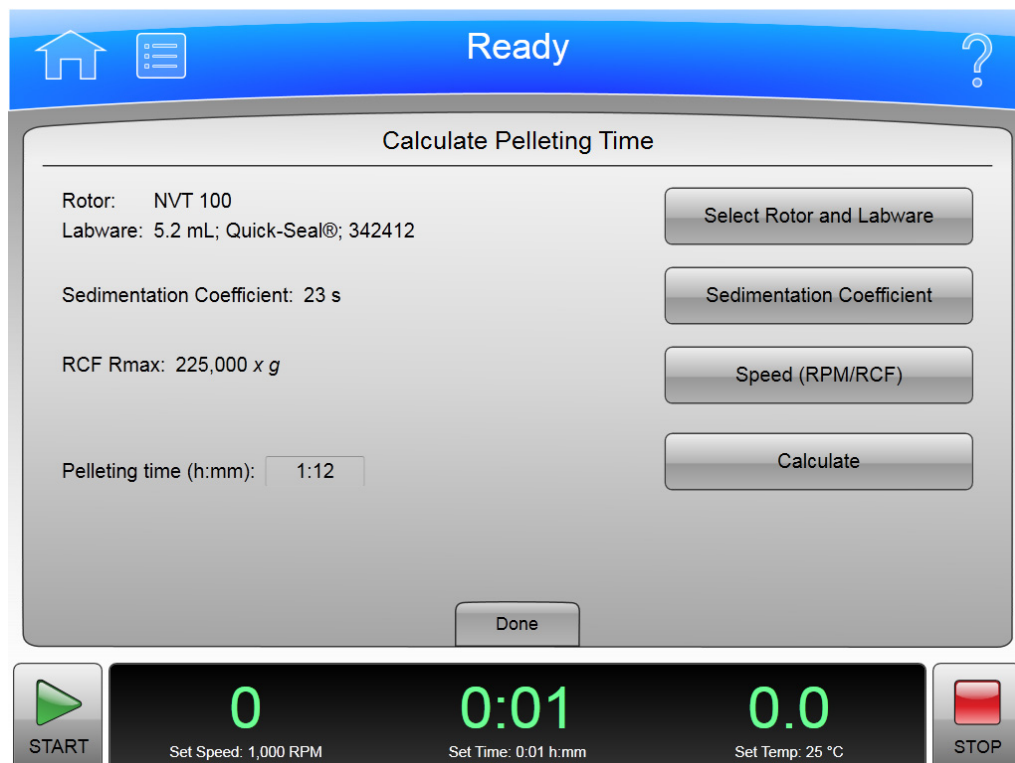
Pelleting Time

This function calculates the minimum time required to pellet a particle with a known sedimentation coefficient in water.

To calculate the pelleting time:

- 1 On the Calculations page, select **Pelleting Time**. The system displays the Calculate Pelleting Time page.

Figure 6.7 Pelleting Time Page



-
- 2 Select **Select Rotor and Labware** to select a rotor and labware combination, then select **OK**.

 - 3 Select **Sedimentation Coefficient** to enter the sedimentation coefficient of the particles being separated, then select **OK**.

 - 4 Select **Speed (RPM/RCF)** to enter the speed in RPM or RCF.
NOTE This option is not enabled until a rotor is selected.

 - 5 Select **Calculate**.
The time required to pellet the particles is displayed in the **Pelleting time (h:mm):** field.
NOTE This option is not selectable until a rotor, sedimentation coefficient, and speed are selected.

 - 6 Note the calculated time, then select **Done** to return to the Calculations page.
-

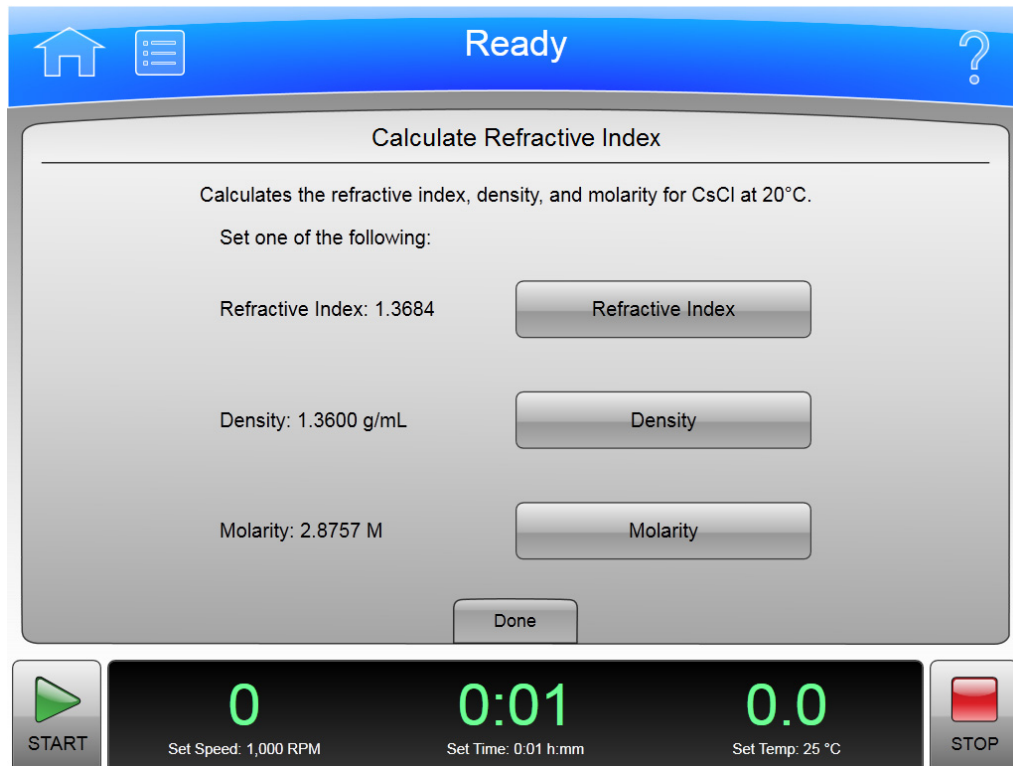
Refractive Index

Calculates the values for the refractive index, density, and molarity for CsCl at 20°C.

To calculate the refractive index, density, or molarity:

-
- 1 On the Calculations page, select **Refractive Index**.
The system displays the Calculate Refractive Index page.

Figure 6.8 Calculate Refractive Index Page



2 Enter the value for one of the following options:

- **Refractive Index**
- **Density**
- **Molarity**

The remaining two parameters are calculated and displayed.

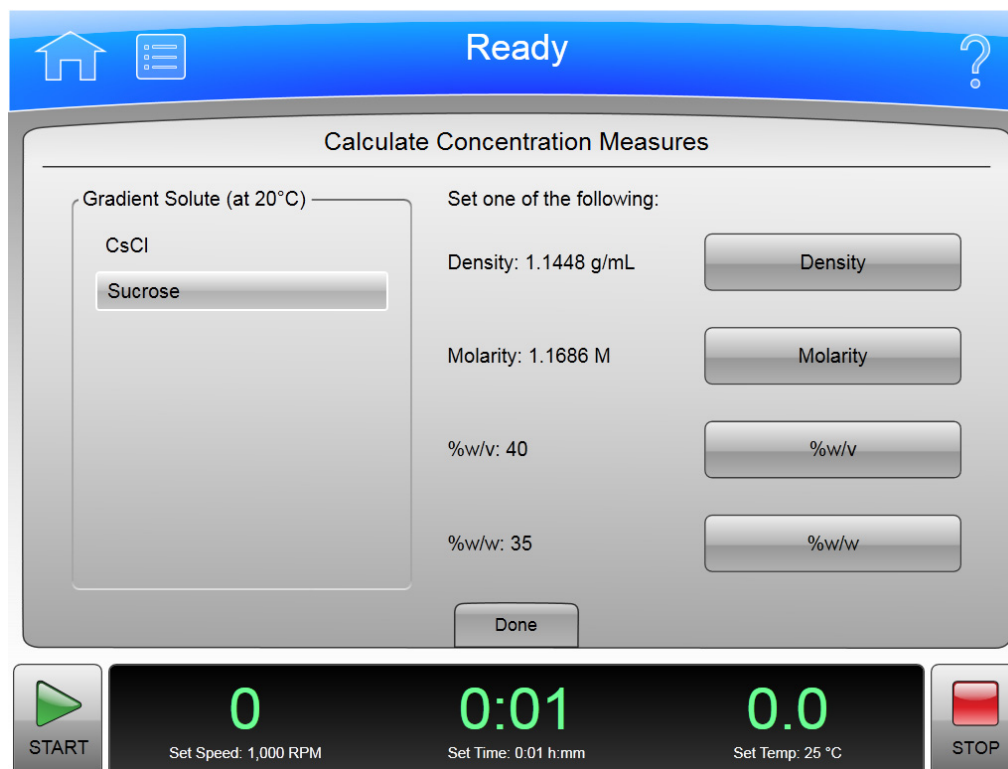
3 Note the calculated parameters, then select **Done** to return to the Calculations page.

Concentration Measures

This function converts between concentration measures.

1 On the Calculations page, select **Concentration Measures**. The system displays the Calculate Concentration Measures page.

Figure 6.9 Calculate Concentration Measures Page



- 2 Select a gradient solute (CsCl or Sucrose).
- 3 Enter the value for one of the following options:
 - **Density**
 - **Molarity**
 - **%w/v** (weight-to-volume concentration)
 - **%w/w** (weight-to-weight concentration)

The remaining three parameters are calculated and displayed.

- 4 Note the calculated parameters, then select **Done** to return to the Calculations page.

Using Simulations

The Simulations page creates simulations of a variety of run conditions commonly used in ultracentrifugation. These simulations help simplify run preparation.

ESP™ (Efficient Sedimentation Program) predicts optimum run conditions for the separation of particles over a wide variety of rotor and tube combinations. The program calculates the movement of particles in solution as a function of speed and the geometry of different rotor and tube combinations. The program starts at the maximum rated speed of the rotors (or a lower speed if the overall solution density exceeds the limit of the rotor/tube combination selected), and simulates the separation of particles in a sequence.

NOTE ESP provides an estimate only and should be used as a starting point for more detailed experimentation.

The Simulations function includes the following options:

- [ESP RNA Pelletting Best Run](#)
- [ESP RNA Pelletting Fast Run](#)
- [ESP Pelletting Run](#)
- [ESP Rate Zonal Run](#)
- [ESP Plasmid Run](#)
- [Substitute Rotor Run](#)

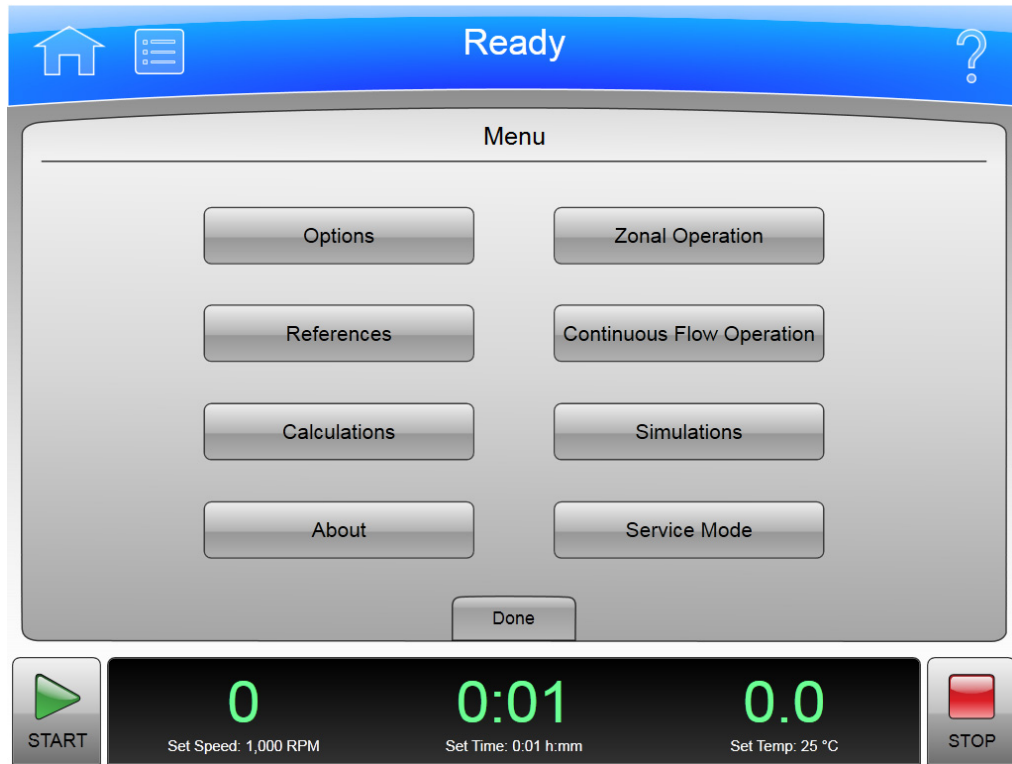
The following sections describe how to access the Simulations page and use the options.

Simulations Page

To access the Simulations page:

-
- 1 On the **Menu** page, select **Simulations**.

Figure 7.1 Menu Page



The system displays the Simulations page.

Figure 7.2 Simulations Page



ESP RNA Pelleting Best Run

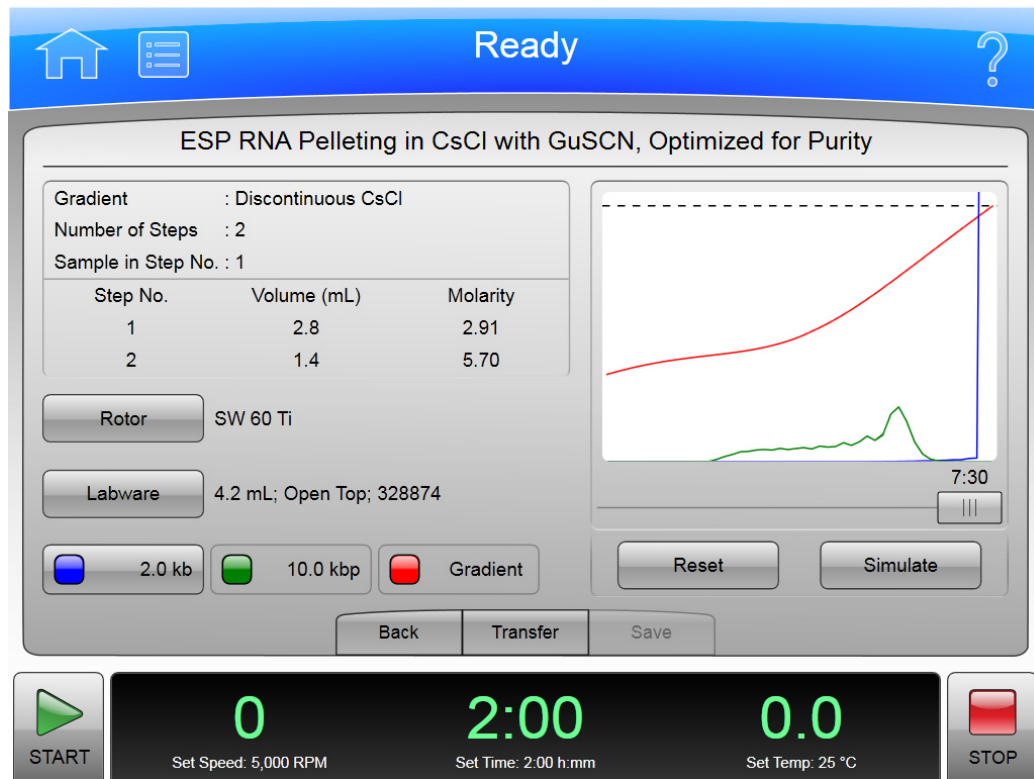
This function simulates separation of RNA molecules in the range 0.1 to 3.0 kb from the chromosomal DNA through a cushion of 5.7 M CsCl at 25°C in a swinging bucket rotor. In the simulation, the sample suspended in 2.91 M Cesium Chloride (CsCl) containing 4 M Guanidine Thiocyanate (GuSCN) layered over a CsCl cushion occupying one-third of the tube volume. The simulation is optimized for purity.

To simulate an ESP RNA pelleting run optimized for purity:

- 1 On the **Simulations** page, select **ESP RNA Pelleting Best Run**.

The system displays the ESP RNA Pelleting in CsCl with GuSCN, Optimized for Purity page.

Figure 7.3 ESP RNA Pelleting in CsCl with GuSCN, Optimized for Purity Page



- 2 Select **Rotor** or **Labware** to select a rotor and labware combination, then select **OK**.

NOTE For this simulation, only swinging bucket rotors are available.

- 3 Select the button with the blue indicator to enter the value for the molecular weight of RNA to be separated, then select **OK**.

- 4 Select **Simulate**. The simulation is displayed on the graph.

The following describes the graph:

- The blue curve represents the relative concentration of the RNA.
- The green curve represents the relative concentration of the DNA contaminant.
- The red curve represents the density of the CsCl gradient along the tube.
- The dashed line at the top of the graph represents the concentration at which CsCl precipitates.

The simulation shows the relative positions of DNA and RNA along the tube length. Move the slider to the left to display separations at shorter run times.

- 5 To simulate another run, select **Reset** to clear all the parameters that were entered.

- 6 Select **Transfer** to transfer the current simulated run settings to the instrument settings for a live run. Select **Save** to save the current simulated run settings as a named run program, which can be run at a later time.

ESP RNA Pelleting Fast Run

This function simulates separation of RNA molecules in the range 0.1 to 3.0 kbp from the sheared chromosomal DNA molecules through a cushion of 5.7 M CsCl at 25°C in a swinging bucket rotor. In the simulation, the sample suspended in 4 M GuSCN and layered over a CsCl cushion occupying one-fourth of the tube volume. This simulation is optimized for speed.

To simulate an ESP RNA pelleting run optimized for speed:

- 1 On the **Simulations** page, select **ESP RNA Pelleting Fast Run**.
The system displays the ESP RNA Pelleting in CsCl with GuSCN, Optimized for Speed page.

Figure 7.4 ESP RNA Pelleting in CsCl with GuSCN, Optimized for Speed Page



- 2 Select **Rotor** or **Labware** to select a rotor and labware combination, then select **OK**.

NOTE For this simulation, only swinging bucket rotors are available.

3 Select the button with the blue indicator to enter the value for the molecular weight of RNA to be separated, then select **OK**.

4 Select **Simulate**. The simulation is displayed on the graph.

The following describes the graph:

- The blue curve represents the relative concentration of the RNA.
- The green curve represents the relative concentration of the DNA contaminant.
- The red curve represents the density of the CsCl gradient along the tube.
- The dashed line at the top of the graph represents the concentration at which CsCl precipitates.

Move the slider to the left to display separations at shorter run times.

5 To simulate another run, select **Reset** to clear all the parameters that were entered.

6 Select **Transfer** to transfer the current simulated run settings to the instrument settings for a live run. Select **Save** to save the current simulated run settings as a named run program, which can be run at a later time.

ESP Pelleting Run

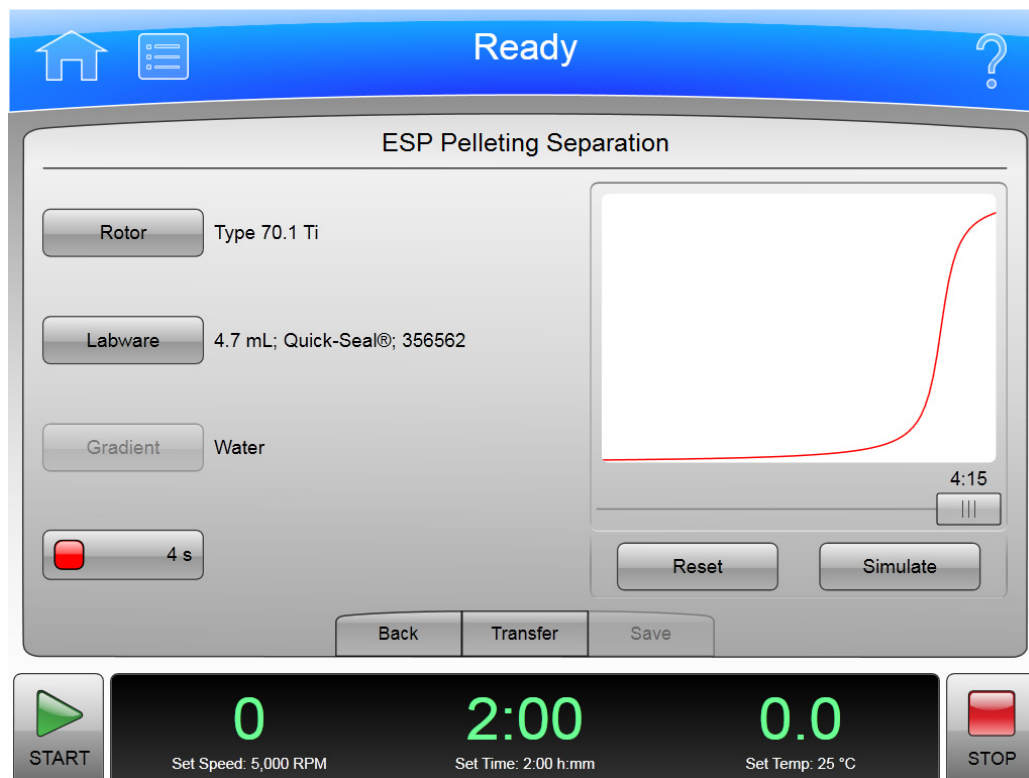
This function simulates separation of particles with known sedimentation coefficients. ESP simulates and predicts the shortest possible run time at which pelleting is achieved.

To set up an ESP pelleting run:

1 On the **Simulations** page, select **ESP Pelleting Run**.

The system displays the ESP Pelleting Separation page.

Figure 7.5 ESP Pelleting Separation Page



- 2 Select **Rotor** or **Labware** to select a rotor and labware combination, then select **OK**.
- 3 Select the button with the red indicator to enter the value for Sedimentation Coefficient for the particle to be pelleted, then select **OK**.

NOTE A sedimentation coefficient value is usually reported as $s_{20,w}$, which means at 20°C in water. ESP simulates the separation of particles in water at a set temperature. Therefore, for the run, enter sedimentation coefficients that correspond those in water at a set temperature.
- 4 Select **Simulate**. The simulation is displayed on the graph.
 The red curve represents the movement of the solute as it pellets.
 Move the slider to the left to display pelleting at shorter run times.
- 5 To simulate another run, select **Reset** to clear all the parameters that were entered.

- 6 Select **Transfer** to transfer the current simulated run settings to the instrument settings for a live run. Select **Save** to save the current simulated run settings as a named run program, which can be run at a later time.

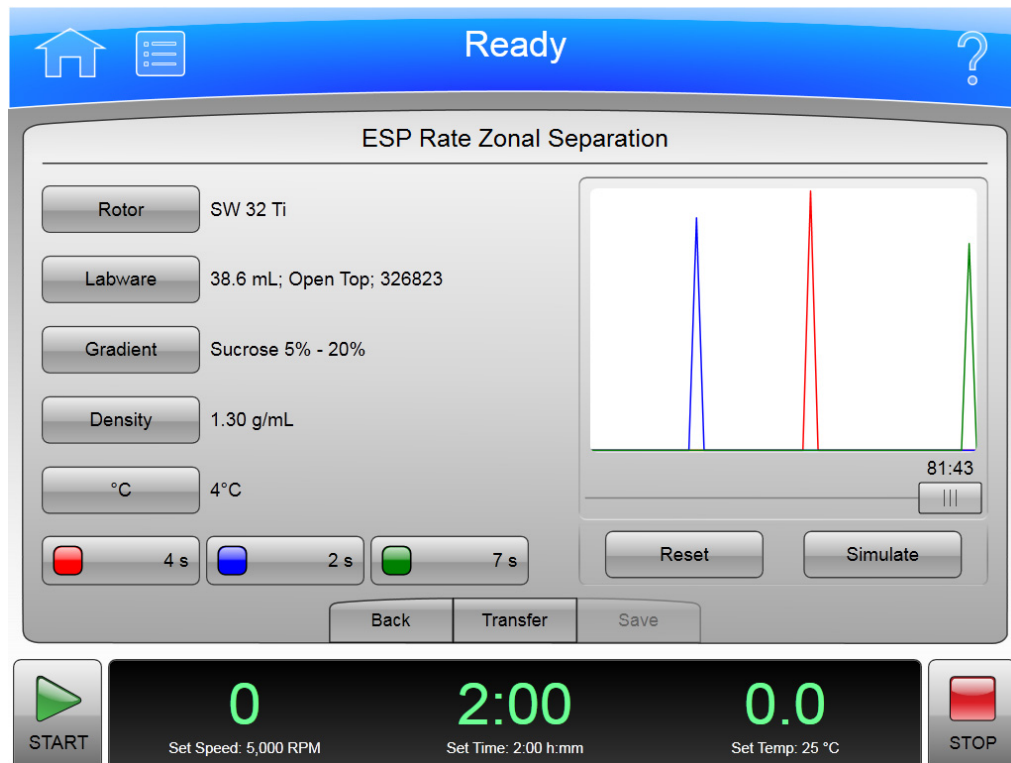
ESP Rate Zonal Run

This function simulates particle separation achieved with rate zonal separation, which is a function of the sedimentation coefficient and density of the particles, and the viscosity of the gradient material. Under centrifugal force, particles migrate as zones. Rate zonal separation is time dependent. ESP simulates the separation of particles as a function of time and radial position.

To create an ESP rate zonal run simulation:

- 1 On the **Simulations** page, select **ESP Rate Zonal Run**.
The system displays the ESP Rate Zonal Separation page.

Figure 7.6 ESP Rate Zonal Separation Page



- 2 Select **Rotor** or **Labware** to select a rotor and labware combination, then select **OK**.

NOTE For this simulation, only swinging bucket rotors are available.

-
- 3** Select **Gradient** to select the gradient of the Sucrose solution, then select **OK**.
For more information on gradients, refer to the Calculations chapter.

 - 4** Select **Density** to enter the density in g/mL of the particles to be separated, then select **OK**.

 - 5** Select **°C** to enter the run temperature, then select **OK**.

 - 6** Select the buttons with the colored indicators to enter the values for Sedimentation Coefficient of the particles, then select **OK**.
Users can enter up to three sedimentation coefficients for three particles.
NOTE A sedimentation coefficient value is usually reported as $s_{20,w}$, which means at 20°C in water. The ESP is designed to simulate the separation of particles in Sucrose with density gradients at a set temperature. Therefore, for the simulation, enter sedimentation coefficients that correspond to those in Sucrose at a set temperature.

 - 7** Select **Simulate**. The simulation is displayed on the graph.
The green, blue, and red curves represent the sedimentation coefficients of the three particles. Move the slider to the left to display conditions at shorter run times.

 - 8** To simulate another run, select **Reset** to clear all the parameters that were entered.

 - 9** Select **Transfer** to transfer the current simulated run settings to the instrument settings for a live run. Select **Save** to save the current simulated run settings as a named run program, which can be run at a later time.
-

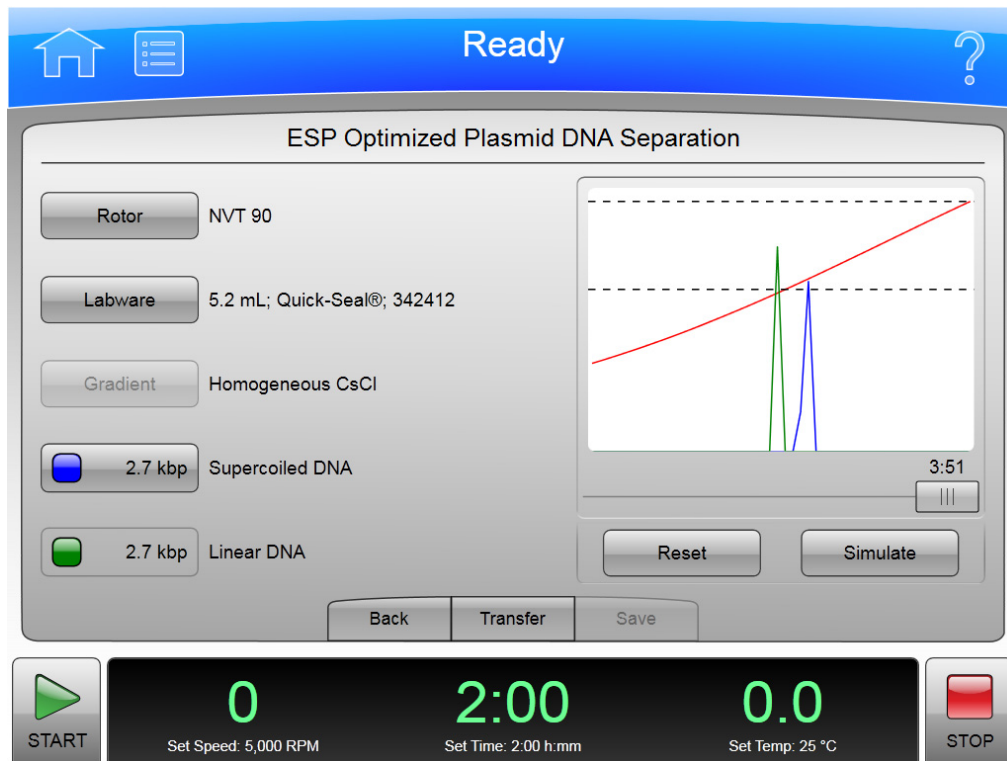
ESP Plasmid Run

This function simulates an optimized plasmid DNA separation in homogeneous 1.55 g/mL CsCl-EtBr at 25°C, and controls rotor speed to prevent CsCl precipitation. The simulation predicts the length of time required to achieve a stable separation of the supercoiled (intact) and linear (nicked) plasmid DNA.

To create an ESP plasmid run simulation:

-
- 1** On the **Simulations** page, select **ESP Plasmid Run**.
The system displays the ESP Optimized Plasmid DNA Separation page.

Figure 7.7 ESP Optimized Plasmid DNA Separation Page



- 2 Select **Rotor** or **Labware** to select a rotor and labware combination, then select **OK**.
- 3 Select the button with the blue indicator to enter the value for molecular weight of DNA, then select **OK**.
The same value of molecular weight entered for supercoiled DNA appears in the button with the green indicator, representing the linear (nicked) DNA of the same molecular weight.

- 4 Select **Simulate**. The simulation is displayed on the graph.

The following describes the graph:

- The green curve represents the relative concentration of linear DNA.
- The blue curve represents the relative concentration of supercoiled DNA.
- The red curve represents the density of the CsCl gradient along the tube.
- The dashed line at the top of the graph represents the concentration at which CsCl precipitates.
- The dashed line near the middle of the graph represents the initial density (1.55 g/mL) of the gradient.

Move the slider to the left to display separations at a shorter run time.

- 5 To simulate another run, select **Reset** to clear all the parameters that were entered.
- 6 Select **Transfer** to transfer the current simulated run settings to the instrument settings for a live run. Select **Save** to save the current simulated run settings as a named run program, which can be run at a later time.

Substitute Rotor Run

This function converts a set of run settings from one type of rotor and labware to another in order to achieve approximately comparable results and allows conversion of runs from non-Beckman Coulter equipment (rotors from other manufacturers) to run on the Optima XPN.

To convert a set of run settings:

- 1 On the **Simulations** page, select **Substitute Rotor Run**.
The system displays the Substitute Rotor Run page.

Figure 7.8 Substitute Rotor Run Page



-
- 2 To set the source rotor, in the Source Rotor area, select one of the following:
 - **Rotor/Labware**
This option sets the Rmin/Rmax parameters automatically.
 - **Rmin/Rmax**
Use this option to select non-Beckman Coulter or other unsupported rotors that are either obsolete or discontinued. Enter values that correspond to meniscus and inside-bottom of the labware positions at speed, respectively. These are the distances from the axis of rotation in millimeters.

 - 3 Select **OK**.

 - 4 Select **Speed/Time** to enter the run speed and elapsed run time, then select **OK**.

 - 5 To set the target rotor, in the Target Rotor area, select **Rotor/Labware** to select a rotor and labware combination, then select **OK**.

 - 6 Select **Temperature** to set the temperature, then select **OK**.

 - 7 Select **Speed** to set the desired run speed, then select **OK**.
Once the target parameters are set, the results are automatically shown in the **Run Parameters** area.

 - 8 Select **Transfer** to transfer the substitute rotor run settings to the instrument settings for a live run. Select **Save** to save the substitute rotor run settings as a named run program, which can be run at a later time.
-

CHAPTER 8

Functional Pages

This chapter describes the functional pages used to control the Optima XPN. They include all of the following:

- Home Page
- Set Speed Page
- Set Time Page
 - Delay Start Page
- Set Speed ω^2t Time Page
- Set Temperature Page
- Set Acceleration/Deceleration Profiles Page
- Login Page
- Select Program Page
 - New/Edit/View Program Page
 - Select Rotor and Labware Page (Catalog)
 - New/Edit Step Page
 - Program Log Page
 - Export Page
 - Authorize Users Page
 - Import Page
- Real-Time Run Data/Historical Run Data Page
 - Run Graph Options Page
- Run History Page
 - Run History Filter Page
- Before Run/After Run Comment Page
- Menu Page
 - System Options Page
 - The Basic Tab
 - Select Language Page
 - User Options Page
 - Reset User PIN Page
 - Select Image Page

- The System Tab
 - Set Date and Time Page
 - System Log Page
 - Manage Rotors Page
 - Add to Rotor Library Page
 - Diagnostic History Page
 - Set Sound Page
 - Custom Sounds Page
 - Archive Data Page
- The Network Tab
 - Setup Network Page
 - Select Printer Page
 - Setup Email Page
 - Setup VNC Page
- The Users Tab
 - Manage Users Page
 - Add/Edit User Page
 - Authorize Programs Page
- The Reports Tab
- References Page
 - Rotor Catalog Page
 - Compatible Tubes for Rotor Page
 - Labware Catalog Page
 - Chemical Resistances Page
- Calculations Page
 - Reduce Rotor Speed for Dense Solutions Page
 - Reduce Rotor Speed for Precipitating Solutions Page
 - Determine Sedimentation Coefficient from Run Data Page
 - Determine Sedimentation Coefficient from Molecular Mass Page
 - Calculate Pelleting Time Page
 - Calculate Concentration Measures Page
 - Calculate Refractive Index Page
- About Page
- Zonal/Continuous Flow Authorization Page
 - Zonal/Continuous Flow Operation Page

- [Simulations Page](#)
 - [ESP RNA Pelleting in CsCl with GuSCN, Optimized for Purity Page](#)
 - [Select Rotor and Labware Page \(Catalog/Library\)](#)
 - [ESP RNA Pelleting in CsCl with GuSCN, Optimized for Speed Page](#)
 - [ESP Pelleting Separation Page](#)
 - [ESP Rate Zonal Separation Page](#)
 - [ESP Optimized Plasmid DNA Separation Page](#)
 - [Substitute Rotor Run Page](#)

Home Page

Figure 8.1 Home Page



The **Home** page is the first operational page to appear after the instrument startup. To display the Home page, select the **Home** page button on the Header Bar. It is the basic page from which you begin most operations. The large fields are designed for viewing from a distance.

You can select the **Home** page button to reset the system and clear the pages you have previously displayed from cache.

In addition to the Header Bar and the Footer Bar, the **Home** page contains the following elements:

- The ω^2t Display.
The ω^2t Display appears only when you have enabled ω^2t mode on the [System Options Page](#). It shows the accumulated ω^2t value for the run in progress. See the [Set Speed \$\omega^2t\$ Time Page](#) for details.

- The **Set Speed** Display/Button.

The **Set Speed** Display/Button shows the current rotor speed as a large number and also shows the current run speed setting in small characters across the bottom. Select the **Set Speed** Display/Button to display the [Set Speed Page](#) (or to the [Set Speed \$\omega^2t\$ Time Page](#) if the ω^2t mode is active). When you are not on the **Home** page, the **Set Speed** Display/Button appears in the Footer Bar.

- The **Set Time** Display/Button.

The **Set Time** Display/Button shows the current remaining run time as a large number and also shows the current run duration setting in small characters across the bottom. Before you begin a run, the numbers are the same. During a run, the large number counts down to zero.

NOTE In Hold mode, the time counts up to show the length of time the instrument has been running, and continues to increment until you select Stop or the maximum run time elapses.

Select the **Set Time** Display/Button to display the [Set Time Page](#) ([Set Speed \$\omega^2t\$ Time Page](#) if the ω^2t mode is active). When you are not on the **Home** page, the **Set Time** Display/Button appears in the Footer Bar.

- The **Set Temp** Display/Button.

The **Set Temp** Display/Button shows the current rotor temperature as a large number and also shows the current temperature setting in small characters across the bottom. Select the **Set Temp** Display/Button to display the [Set Temperature Page](#). When you are not on the **Home** page, the **Set Temp** Display/Button appears in the Footer Bar.

- The Side Menu

The Side Menu must be accessed from the **Home** page, and includes the following buttons:

- If your system requires login, the Login/Logout button. Select this button to log in or out of the system.
- The Program button. Select this button to display the [Select Program Page](#).
- The Run Graph button. Select this button to display the [Real-Time Run Data/Historical Run Data Page](#).
- The Zonal Mode button. Select this button to display the [Zonal Authorization Page](#).

The **Vacuum** Display/Button on the Footer Bar shows the current chamber vacuum of the run that is in progress, and the action that will be performed if you select the button. The button toggles between evacuating and venting. Select it before you start a run (after the door is closed) to begin evacuating and pre-conditioning the chamber. Select it at the end of a run (assuming speed is less than 3000 rpm and decelerating) to release the vacuum (i.e., vent the chamber).

When you use Zonal mode or Continuous Flow mode, the [Zonal/Continuous Flow Operation Page](#) replaces the **Home** page.

Home Page (Run in Progress)

Figure 8.2 Home Page (Run in Progress)



When an actual run is in progress, the **Home** page includes the following information:

- The **Set Speed** Display shows the actual speed of the rotor in RPM or RCF.
- The **Set Time** Display shows the time remaining in the run or the present step of the run program. If the time setting is Hold, it displays the actual run time elapsed.
- The **Set Temp** Display shows the current actual temperature of the run in degrees Celsius.

Animated arrows on each display show whether the speed, time and temperature are increasing or decreasing.

The **Vacuum** Display/Button on the Footer Bar shows the current chamber vacuum, and the action that will be performed if you select the button.

Set Speed Page

Figure 8.3 Set Speed Page (No Rotor Selected)

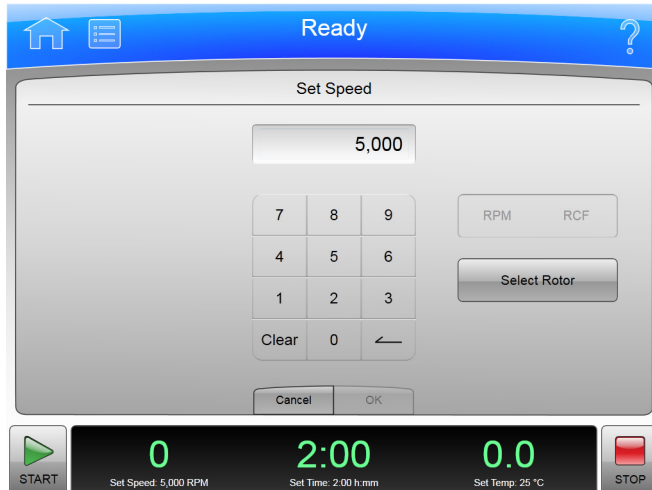
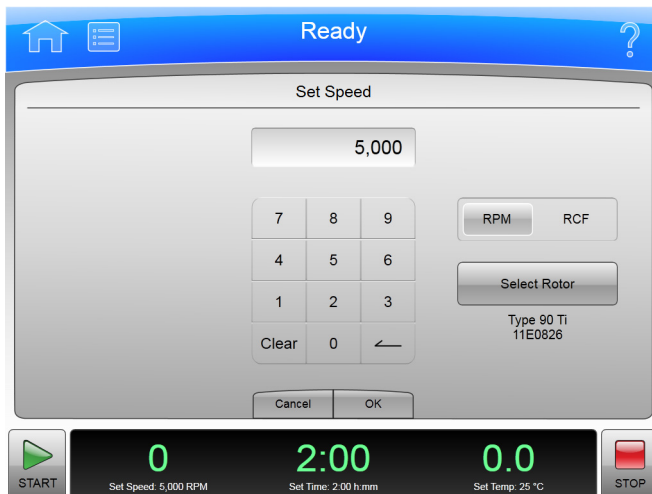


Figure 8.4 Set Speed Page (Rotor and Labware Selected)



To set the speed for the next run or change the speed of the run in progress, select the **Set Speed** Display/Button on the [Home Page](#) or the Footer Bar to display the **Set Speed** page. If you have selected a rotor, you can select the **RPM RCF** button to set the units in RCF (Relative Centrifugal Field) instead of RPM.

If the instrument is in ω^2t mode, the system displays the [Set Speed \$\omega^2t\$ Time Page](#).

In addition to the Header Bar and the Footer Bar, the **Set Speed** page contains the following elements:

- The Set Speed Display at the top of the page shows the current Set Speed in RPM or RCF. The last two digits are always zeroes when the speed is above 1000 RPM.
- The Keypad changes the speed setting. You can use the **Clear** and **Back** keys to make corrections.
- The **RPM/RCF** button selects the speed units. This button is disabled until a rotor is selected.

- The **Select Rotor** button displays the [Select Rotor and Labware Page \(Library\)](#) page.
- The **Cancel** button discards your changes and dismisses the page.
- The **OK** button saves your entry and dismisses the page.

Select Rotor and Labware Page (Library)

Figure 8.5 Select Rotor and Labware Page (Library)



To select a rotor for the next run, select the **Select Rotor** button on either the [Set Speed Page](#) or the [Set Speed \$\omega^2\$ Time Page](#) to display the **Select Rotor and Labware** page. This page displays the library of rotors that have been entered for your instrument.

In addition to the Header Bar and the Footer Bar, the **Select Rotor and Labware** page contains the following elements:

- The Rotor Library List shows the available rotors for the instrument. Select a rotor from this list. If you select No Rotor, you cannot use RCF units on the **Set Speed** page. If your system requires rotor selection, you must select a rotor before you can start a run.
- When you select a rotor, the Labware List displays the compatible labware. You can optionally select a specific tube from the list.

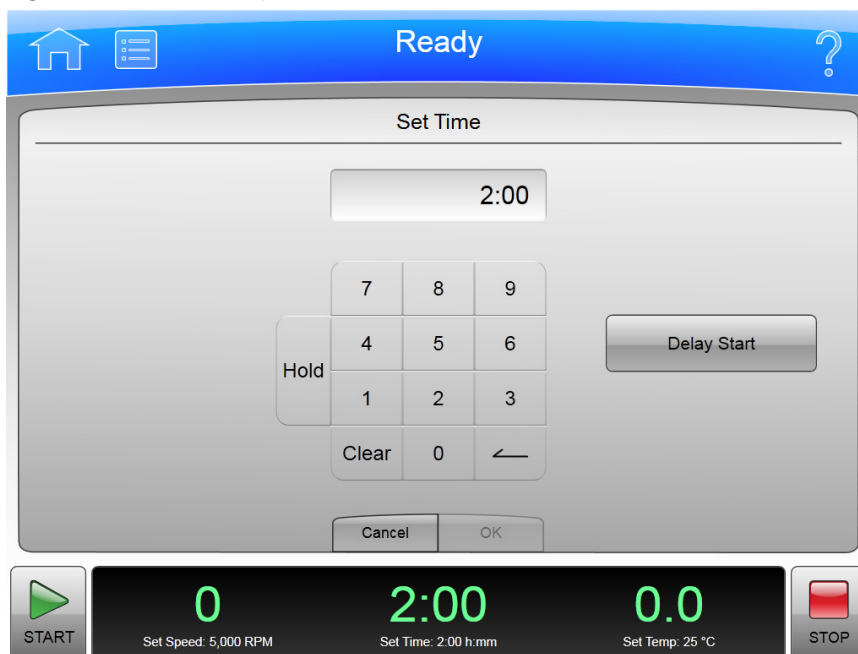
NOTE Under the "Type" field in the Labware list, some of the labware will have a -CF or -S suffix. The -CF suffix indicates the labware is Certified Free of various contaminants. The -S suffix indicates the labware is Sterilized in addition to being Certified Free of contaminants. Search the labware part number on www.beckman.com for more information.

- The **Cancel** button cancels your selection and dismisses the page.
- The **OK** button saves the selection and dismisses the page.

For details about each rotor or type of labware, see the [Rotor Catalog Page](#).

Set Time Page

Figure 8.6 Set Time Page



To set the duration for the next run or change the duration of the run in progress, select the **Set Time** Display/Button on the [Home Page](#) or the Footer Bar to display the **Set Time** page.

If the instrument is in ω^2t mode, the [Set Speed \$\omega^2t\$ Time Page](#) appears instead.

In addition to the Header Bar and the Footer Bar, the **Set Time** page contains the following elements:

- The Set Time Display shows the current **Set Time** setting in hours and minutes.
- The Keypad changes the time setting. You can use the **Clear** and **Back** keys to make corrections.
- The **Hold** key sets the time to a hold state with no countdown to an automatic end. When you select **Hold**, the run does not end until you select the **Stop** key (or until the maximum time of 999 hours and 59 minutes has elapsed).
- The **Delay Start** button displays the [Delay Start Page](#), to set a future time at which to start or end the run. This button is disabled when a run is in progress or a delayed run is pending. (To stop the countdown on a pending delayed run, select **Stop**.)
- The **Cancel** button discards your entry and dismisses the page.
- The **OK** button accepts your entry and dismisses the page.

Delay Start Page

Figure 8.7 Delay Start Page



To set a future start or end time for the next run, select the **Delay Start** button on the [Set Time Page](#) or the [Set Speed \$\omega\$ t Time Page](#) to display the **Delay Start** page.

In addition to the Header Bar and the Footer Bar, the **Delay Start** page contains the following elements:

- The current time in hours and minutes and the length of time currently set for the run.
- The **No Delay** button (default) sets the run start time to the present and disables the Date/Time scroll arrows.
- The **Start At** button enables the Date/Time scroll arrows and sets the run to start at the time entered.
- The **Stop At** button enables the Date/Time scroll arrows and sets the run to end at the time entered. The system calculates the start time by subtracting the Run time from the Stop At time.
- The Date/Time scroll arrows change the date or time setting.
- The **Cancel** button discards your entry and dismisses the page.
- The **OK** button accepts your entry and dismisses the page.

Set Speed ω^2t Time Page

Figure 8.8 Set Speed ω^2t Time Page



When the ω^2t mode is active and you select either the **Set Speed** button or the **Set Time** button on the [Home Page](#) or the Footer Bar, the system displays the **Set Speed ω^2t Time** page. The ω^2t value is computed from the time and RPM (or RCF) values you enter. Use this page to set the values for the next run that produce the desired ω^2t value.

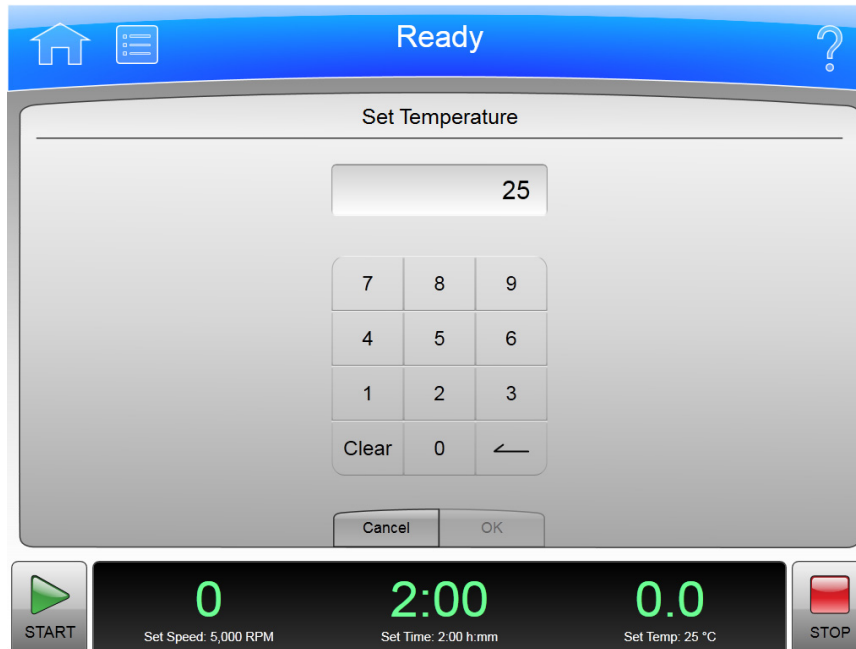
Use the **ω^2t Mode** button on [The Basic Tab](#) of the [System Options Page](#) to enable or disable ω^2t mode.

In addition to the Header Bar and the Footer Bar, the **Set Speed ω^2t Time** page contains the following elements:

- The **Set Speed** Display/Button shows the current Speed in RPM or RCF. Select this button to set a new speed value. The system then changes the ω^2t or time value, whichever you entered last, to reflect the new speed value.
- The ω^2t Display/Button shows the current ω^2t value. Select this button to set a new ω^2t value. The time then changes to reflect the new ω^2t value.
- The **Set Time** Display/Button shows the current time setting in hours and minutes. Select this button to set a new time value. The ω^2t value then changes to reflect the new time value.
- Use the **RPM/RCF** button to select the speed units. You must have a rotor selected to use RCF.
- The **Select Rotor** button displays the [Select Rotor and Labware Page \(Library\)](#).
- The Keypad changes slightly depending on the value you are entering. For setting time, you can use the Hold key to set the time to a hold state with no countdown to an automatic end. For Display/Button setting ω^2t , use the decimal and e keys to enter values in exponential notation. You can use the **Clear** and **Back** keys to make corrections.
- The **Delay Start** button displays the [Delay Start Page](#).
- The **Cancel** button discards your changes and dismisses the page.
- The **OK** button accepts your changes and dismisses the page.

Set Temperature Page

Figure 8.9 Set Temperature Page



To set the temperature for the next run or change the temperature for the run in progress, select the **Set Temperature** button on the [Home Page](#) or the Footer Bar to display the **Set Temperature** page.

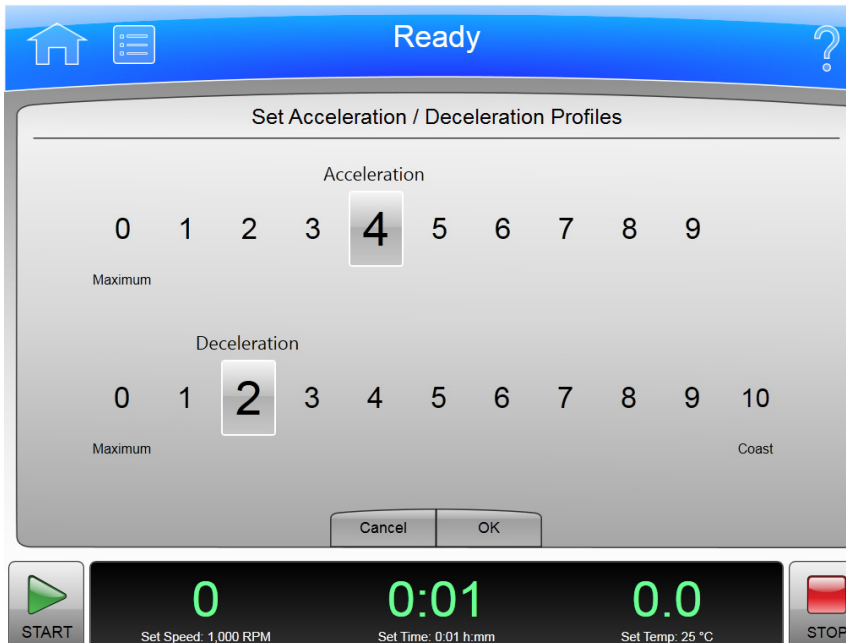
In addition to the Header Bar and the Footer Bar, the **Set Temperature** page contains the following elements:

- The Set Temperature Display shows the current **Set Temperature** setting in °Celsius.
- Use the Keypad to change the temperature setting. You can use the **Clear** and **Back** keys to make corrections.
- The **Cancel** button discards your changes and dismisses the page.
- The **OK** button accepts your changes and dismisses the page.

To precondition the chamber to the selected temperature, use the **Vacuum** Display/Button on the Footer Bar of the [Home Page](#).

Set Acceleration/Deceleration Profiles Page

Figure 8.10 Set Acceleration/Deceleration Profiles Page



To choose profiles for acceleration and deceleration, select the **Accel/Decel** Display/Button in the Footer Bar of the [Home Page](#) to display the **Set Acceleration/Deceleration Profiles** page.

In addition to the Header Bar and the Footer Bar, the **Set Acceleration/Deceleration Profiles** page contains the following elements:

- Use Acceleration to select a numbered acceleration value.
- Use Deceleration to select a numbered deceleration value.
- The **Cancel** button discards your changes and dismisses the page.
- The **OK** button accepts your changes and dismisses the page.

The acceleration values are the degree of reduction from the maximum value. The acceleration value of zero is the maximum (no reduction). The acceleration value of 9 is the slowest (maximum reduction). The same applies to the deceleration values. The value 10 is an absolute reduction, eliminating all braking and allowing the rotor to coast to a stop.

Slower (numerically higher) acceleration and deceleration values minimize sample-to-gradient interface disturbance. Each acceleration profile has a designated time that it takes to reach a specified speed. After that, it uses maximum acceleration to reach run speed. For a deceleration profile, the instrument uses maximum deceleration until it reaches the specified speed, then takes the designated time to slow to a stop.

Example Acceleration and Deceleration Profiles

The values associated with each acceleration and deceleration profile are given in the tables below.

NOTE The values shown should be considered as approximations for time and rpm.

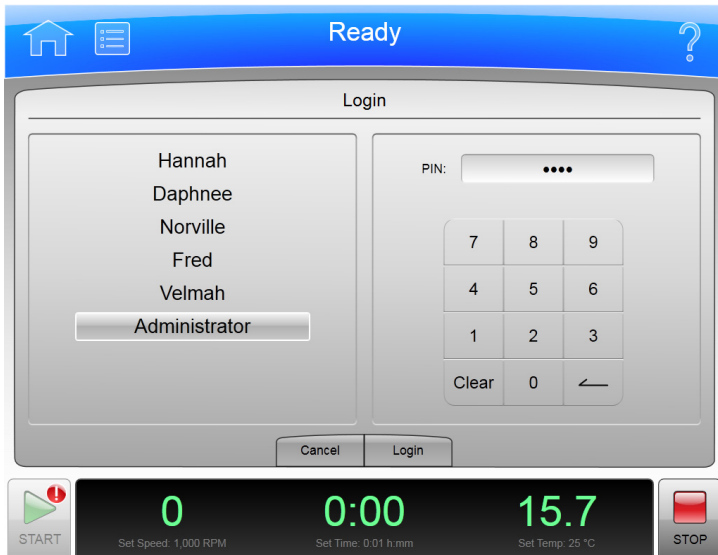
| Acceleration | | | Deceleration | | |
|--------------|------|-----|--------------|-------|-----|
| Profile # | Time | RPM | Profile # | Time | RPM |
| 0 (Max) | 0:00 | 0 | 0 (Max) | 0:00 | 0 |
| 1 | 2:00 | 170 | 1 | 2:00 | 170 |
| 2 | 2:40 | 350 | 2 | 2:40 | 350 |
| 3 | 3:00 | 500 | 3 | 3:00 | 500 |
| 4 | 3:00 | 170 | 4 | 3:00 | 170 |
| 5 | 4:00 | 350 | 5 | 4:00 | 350 |
| 6 | 4:30 | 500 | 6 | 4:30 | 500 |
| 7 | 4:00 | 170 | 7 | 4:00 | 170 |
| 8 | 5:20 | 350 | 8 | 5:20 | 350 |
| 9 | 6:00 | 500 | 9 | 6:00 | 500 |
| | | | 10 | Coast | |

For example, at an acceleration profile value of 5, the instrument takes four minutes to accelerate to 350 rpm, then proceeds to the run speed at maximum acceleration. For a deceleration profile of 3, the instrument uses maximum deceleration until it reaches 500 rpm, then takes three minutes to slow to a stop.

The exception is a deceleration profile of 10, for which no braking is applied. This is generally not used for high-speed runs because of the extreme length of time it would take for the rotor to come to a stop.

Login Page

Figure 8.11 Login Page



If the user login requirement has been enabled for the instrument, you must log in to the system use it. Select the **Login** button on the [Home Page](#) to display the **Login** page.

To enable or disable the user login requirement, select **Require Login** on [The Users Tab](#) of the [System Options Page](#).

- To log in, select your user ID from the list on the left. Use the keyboard to enter your PIN on the right, and select **Login**.
- Select **Cancel** to dismiss the page without logging in.

Select Program Page

Figure 8.12 Select Program Page



To select or manage your run programs, select the **Program** button on the [Home Page](#) to display the **Select Program** page. Operator-level users cannot create or change programs.

In addition to the Header Bar and the Footer Bar, the **Select Program** page contains the following elements:

- Select a program from the list on the left to run, edit, view, or delete. Select **•No Program•** and select **OK** to return to manual mode.
- Select **New** to create a new program. The system displays the [New Program Page](#).
- Select **Edit** to change the selected program. The system displays the [Edit Program Page](#).
- Select **View** to review the selected program without making changes to it. The system displays the [View Program Page](#).
- Select **Delete** to remove the selected program from the list. The system displays a confirmation message. Select **Yes** to remove the program.
- Select **Program Log** to display the [Program Log Page](#) for the selected program.
- Select **Authorize Users** to grant Operator-level users permission to run the selected program. The system displays the [Authorize Users Page](#).
- Select the **Cancel** button to discard your changes and dismiss the page.
- Select **Print** to print the selected program.
- Select **Export** to export the selected program. The system displays the [Export Page](#).
- Select **Import** to import a program. The system displays the [Import Page](#).
- The **OK** button accepts your program selection and dismisses the page. The system will run the selected program when you select **Start**.

New/Edit/View Program Page

Figure 8.13 New Program Page

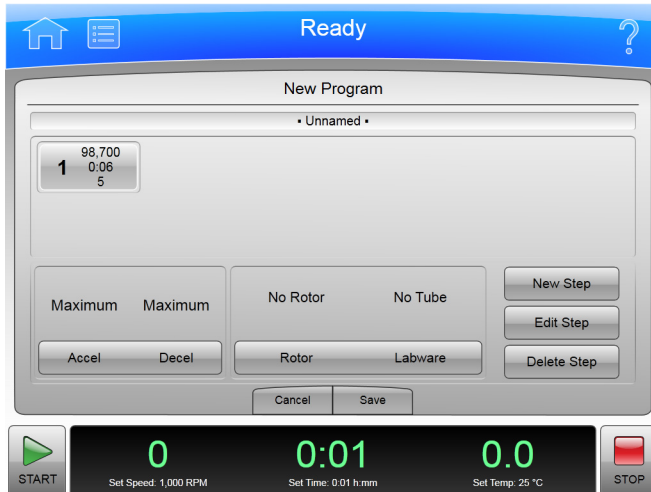


Figure 8.14 Edit Program Page

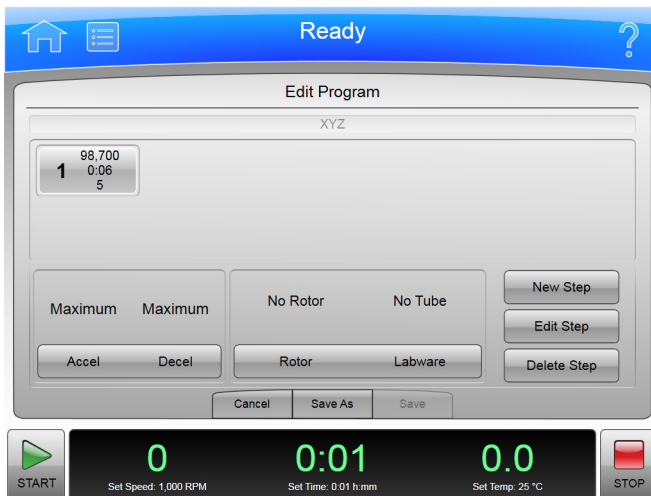
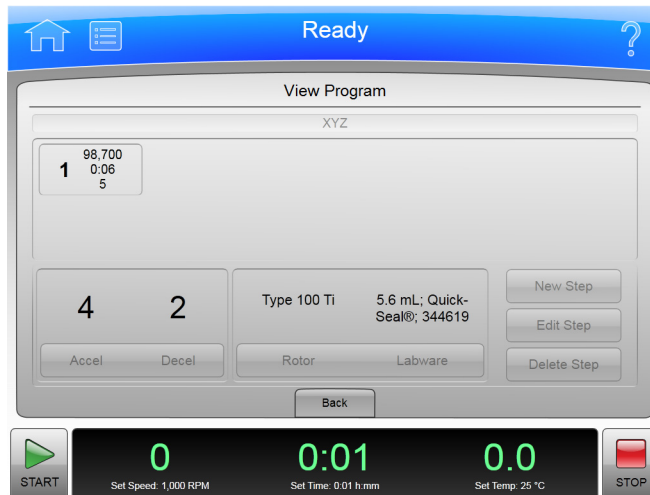


Figure 8.15 View Program Page



To create a run program, select the **New** button on the [Select Program Page](#) to display the **New Program** page. To edit or view a run program, select the program and select the **Edit** or **View** button on the [Select Program Page](#) to display the **Edit Program** or **View Program** page. The pages are identical except for which buttons are active. (The **View Program** page does not permit editing.)

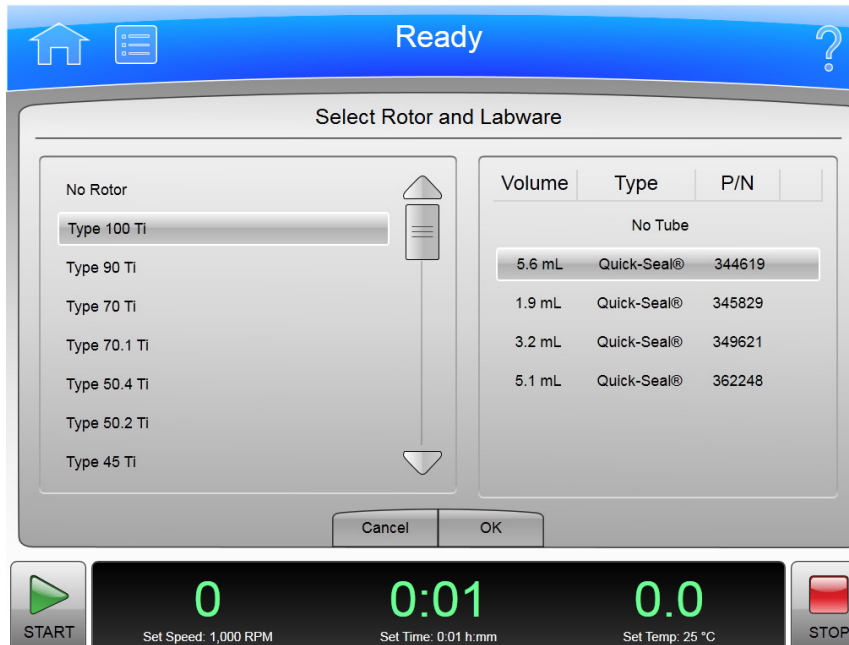
In addition to the Header Bar and the Footer Bar, the **New/Edit/View Program** page contains the following elements:

NOTE No changes can be made on the View Program page.

- The program name appears at the top of the page. New programs appear as **•Unnamed•** until you save them, or select **•Unnamed•** to display the **New Program Name** page. Enter the name of the new program and select **OK** to enter the name.
- Program steps appear in the Step List.
- Acceleration and Deceleration Profiles appear in the Accel/Decel area. Select the **Accel/Decel** button to display the [Set Acceleration/Deceleration Profiles Page](#) to select new profiles.
- The selected rotor type and labware appear in the Rotor/Labware area. To enter or change the rotor or labware, select the **Rotor/Labware** button to display the [Select Rotor and Labware Page \(Catalog\)](#).
- Use the **New Step** button to display the [New Step Page](#) and add a new step to the program.
- To change a step, select the step and select the **Edit Step** button to display the [Edit Step Page](#).
- To delete a step, select the step and select the **Delete Step** button. The system displays a confirmation message. Select **Yes** to delete the step.
- The **Cancel** button discards your changes and dismisses the page.
- From the **Edit Program** page, you can use the **Save As** button to save the changed program as a new program. The system displays the **New Program Name** page. Enter the name of the new program and select **OK** to save the program. The original program remains unchanged.
- The **Save** button saves your entry and dismisses the page.

Select Rotor and Labware Page (Catalog)

Figure 8.16 Select Rotor and Labware Page (Catalog)



To select a type of rotor for a run program, select the **Rotor/Labware** button on the [New Program Page](#) or the [Edit Program Page](#) to display the **Select Rotor and Labware** page (Catalog). This page displays the complete list of rotors that can be used with the XPN.

In addition to the Header Bar and the Footer Bar, the **Select Rotor and Labware** page contains the following elements:

- The Rotor Catalog List shows the rotors that can be used with the instrument. Select a rotor from this list to indicate the kind of rotor that must be used with the run program. When you run the program, the selection from the rotor library will be restricted to rotors of the same kind.
- When you select a rotor, the Labware List displays the compatible labware. You can optionally select a specific type of labware from the list.

NOTE Under the "Type" field in the Labware list, some of the labware will have a -CF or -S suffix. The -CF suffix indicates the labware is Certified Free of various contaminants. The -S suffix indicates the labware is Sterilized in addition to being Certified Free of contaminants. Search the labware part number on www.beckman.com for more information.

- The **Cancel** button cancels your selection and dismisses the page.
- The **OK** button saves the selection and dismisses the page.

For details about each rotor or type of labware, use the [Rotor Catalog Page](#).

New/Edit Step Page

Figure 8.17 New Step Page

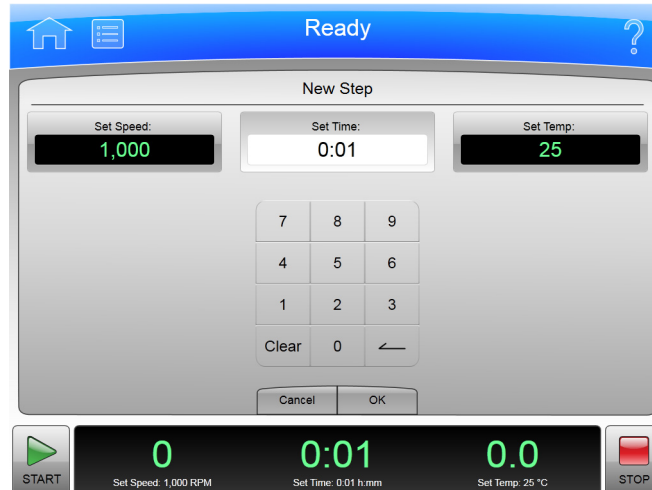
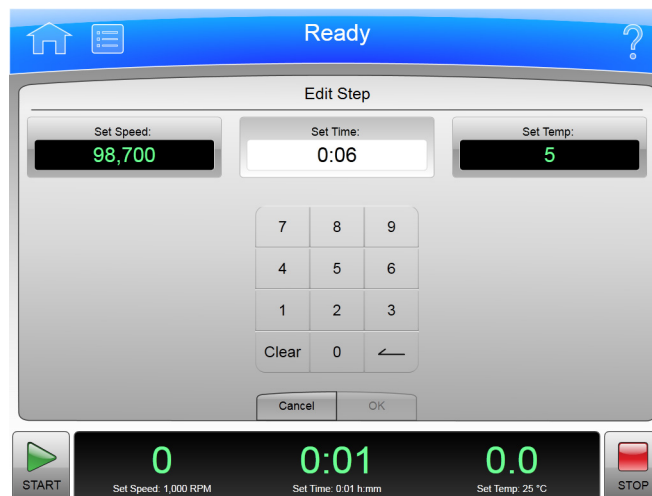


Figure 8.18 Edit Step Page



To create a step within a run program, select the **New Step** button on the [New Program Page](#) or the [Edit Program Page](#) to display the **New Step** page. To edit a step within a run program, select the step and select the **Edit Step** button on the [New Program Page](#) or the [Edit Program Page](#) to display the **Edit Step** page. The pages contain the same options.

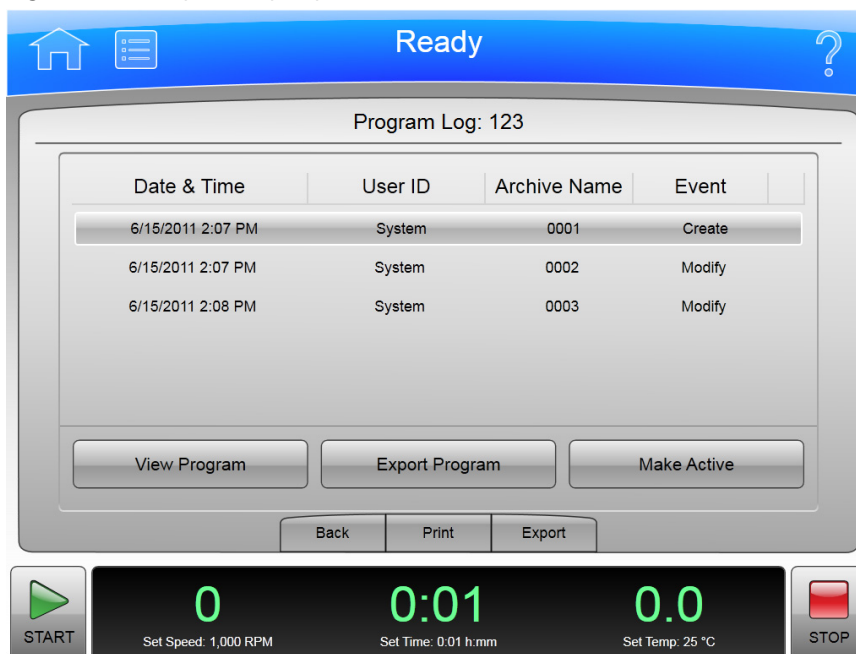
In addition to the Header Bar and the Footer Bar, the **New/Edit Step** page contains the following elements:

- The **Set Speed** field shows the default or the current step Set Speed in RPM. The last two digits are always zeroes. Select the field and use the keypad to change the entry as required.
- The **Set Time** field shows the default or the current step Set Time in hours and minutes. Select the field and use the keypad to change the entry as required.

- The **Set Temp** field shows the default or current step Set Temperature setting in °Celsius. Select the field and use the keypad to change the entry as required.
- Use the Keypad to change the settings as required. You can use the **Clear** and **Back** keys to make corrections.
- The **Cancel** button discards your changes and dismisses the page.
- The **Save** button saves your entry and dismisses the page.

Program Log Page

Figure 8.19 Program Log Page



To display the history of changes to a run program, select the program and select the **Program Log** button on the [Select Program Page](#) to display the **Program Log** page for the selected program.

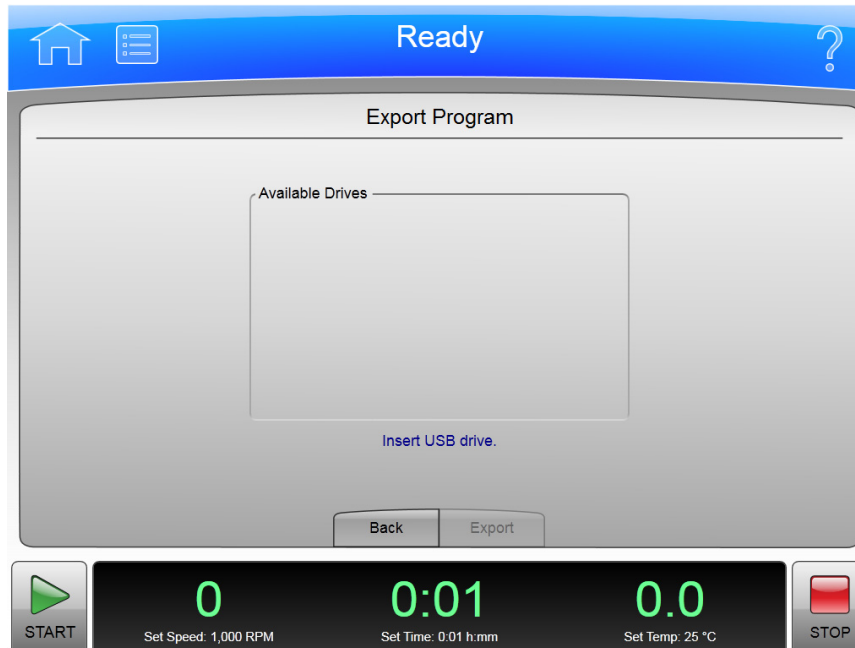
In addition to the Header Bar and the Footer Bar, the **Program Log** page contains the following elements:

- The name of the selected program appears at the top of the page.
- The log entry section lists all versions of the selected program.
- Select a version of the program and select **View Program** to display the [View Program Page](#) for the selected version.
- Select a version of the program and select **Export Program** to export the selected version. The system displays the [Export Page](#).
- Select an older version of the program and select **Make Active** to copy the selected version. The copy becomes the most current version of the program.
- Select the **Back** button to return to the [Select Program Page](#).

- Select **Print** to print the program log.
- Select **Export** to export the program log. The system displays the [Export Page](#).

Export Page

Figure 8.20 Export Page



Different kinds of information can be exported from the XPN to a USB device or network drive. All Export pages function in the same manner.

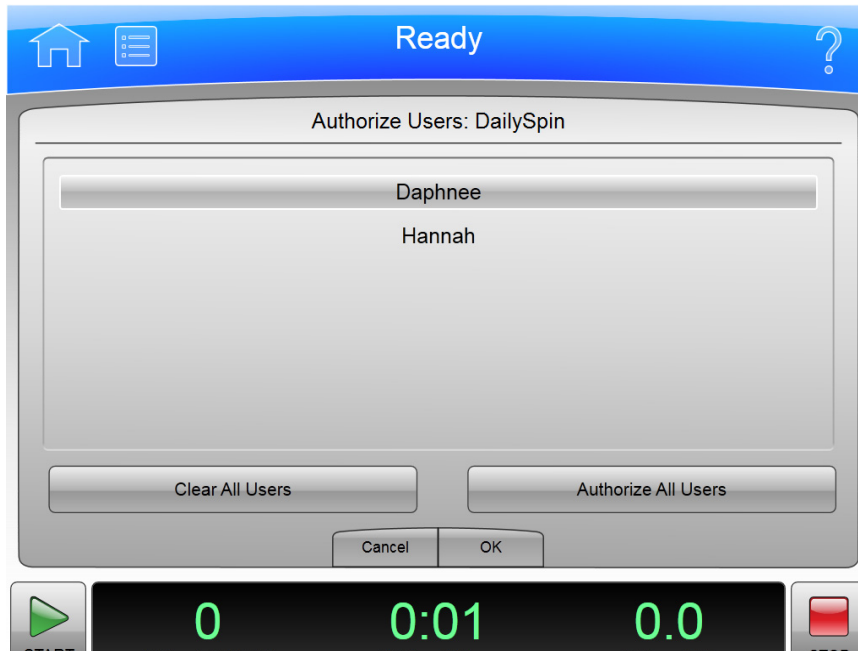
NOTE Do not remove a USB drive while a data transfer is in progress.

In addition to the Header Bar and the Footer Bar, the **Export** page contains the following elements:

- The Export Item at the top tells you what you are about to export (About information, diagnostic messages, programs, the program log, run history, or the User Guide).
- The Available Drives list shows all the available network and USB drives. Attach a USB device if necessary. Select the destination drive.
- The **Back** button returns to the previous page without exporting information.
- The **Export** button copies the information to the selected drive.

Authorize Users Page

Figure 8.21 Authorize Users Page



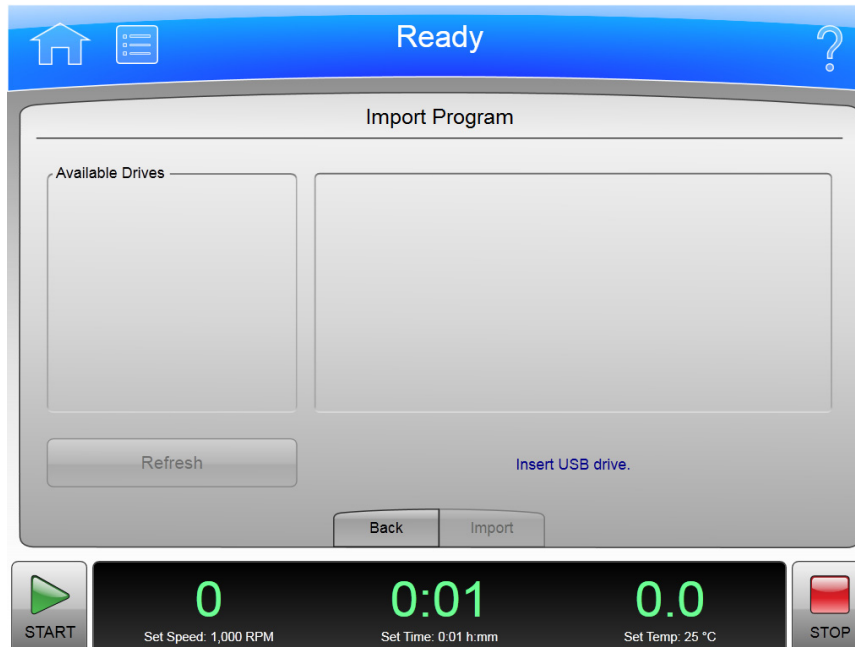
To manage the list of users with permission to run a program, select the program and select the **Authorize Users** button on the [Select Program Page](#) to display the **Authorize Users** page.

In addition to the Header Bar and the Footer Bar, the **Authorize Users** page contains the following elements:

- The program name appears at the top of the page.
- The list box displays the Operator-level users in the system. Users with permission to run the program are highlighted.
- To grant permission to additional users, select the users.
- To remove permission for all users, select **Clear All Users**.
- To grant permission to all current users, select **Authorize All Users**.
- Select the **Cancel** button to discard your changes and return to the [Select Program Page](#).
- Select the **OK** button to accept your changes and return to the [Select Program Page](#).

Import Page

Figure 8.22 Import Page



Many kinds of information can be imported to the XPN from a USB device or network drive. All Import pages function in the same manner.

NOTE Do not remove a USB drive while a data transfer is in progress.

In addition to the Header Bar and the Footer Bar, the **Import** page contains the following elements:

- The Import Item at the top tells you what you are about to import (images, programs).
- The Available Drives list shows all the available network and USB drives. Attach a USB device if necessary. Select the appropriate drive.
- Select **Refresh** to update the file list of the selected drive.
- When you select a drive, the system displays the available files on the right. Select the file to import.
- The **Back** button returns to the previous page without importing information.
- The **Import** button imports the selected file.

Real-Time Run Data/Historical Run Data Page

Figure 8.23 Real-Time Run Data Page

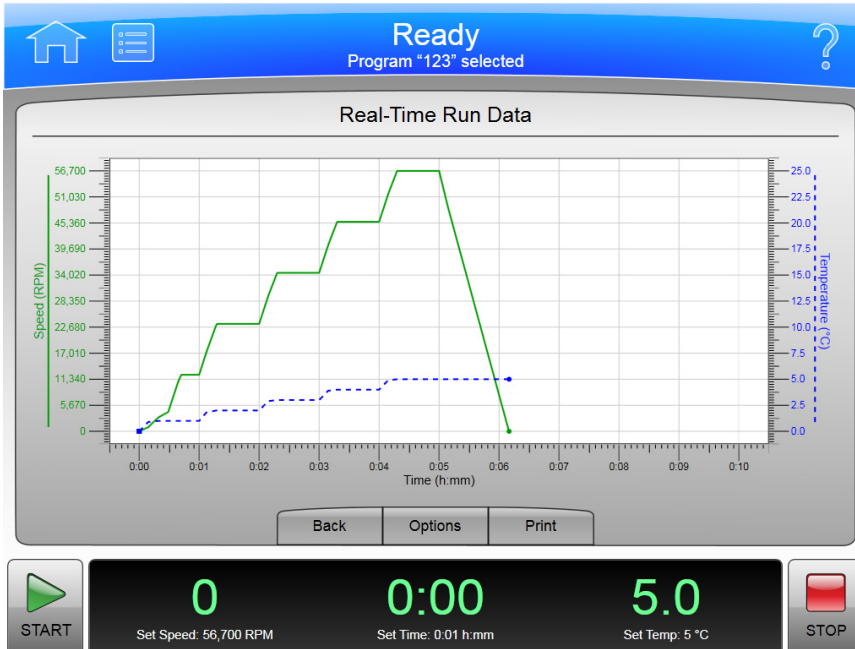
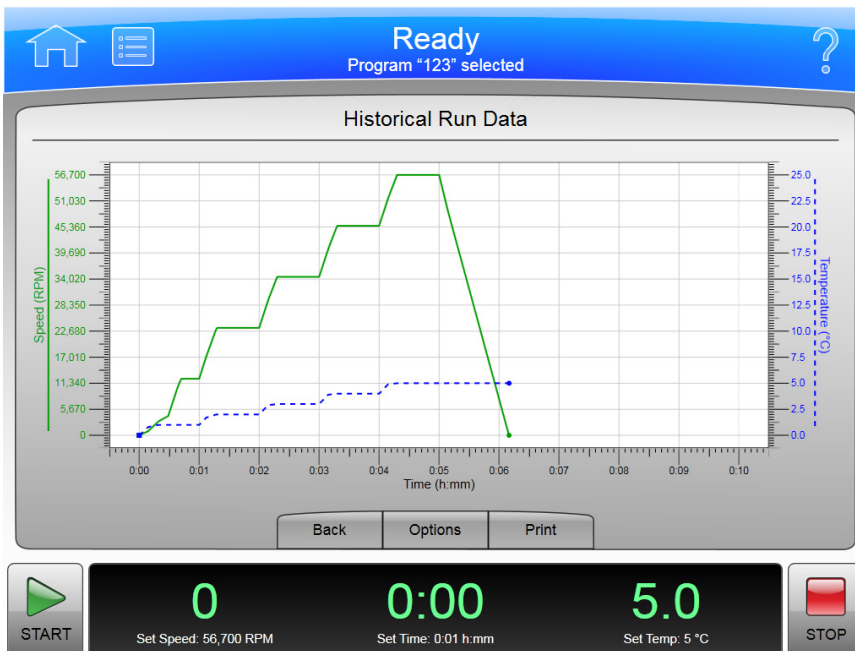


Figure 8.24 Historical Run Data Page



Select the **Run Graph** button on the side menu of the [Home Page](#) to display the **Real-Time Run Data** page. This page graphs the current run as it is in progress, or shows the most recent run.

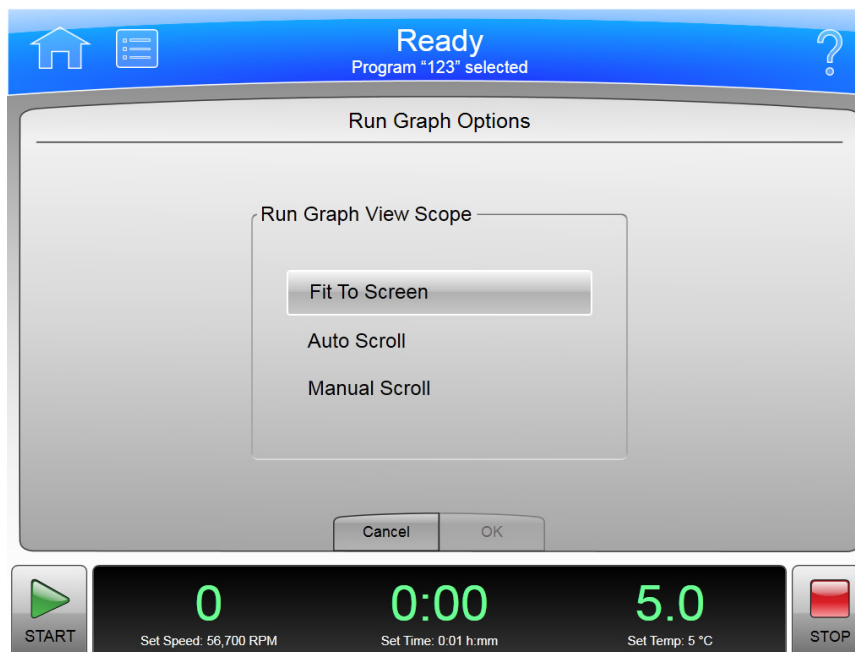
Figure 8.25 Run Graph Button

Select a run log from the [Run History Page](#) and select the **Graph** button to display the **Historical Run Data** page for the selected run.

In addition to the Header Bar and the Footer Bar, the Real-Time Run Data page contains the following elements:

- The **Back** button returns to the previous page.
- The **Options** button displays the Run Graph Options page.
- The **Print** button prints the graph.

Run Graph Options Page

Figure 8.26 Run Graph Options Page

Select the **Options** button on the [Real-Time Run Data/Historical Run Data Page](#) to display the **Run Graph Options** page. Use this page to configure scroll options for your run graph.

In addition to the Header Bar and the Footer Bar, the **Run Graph Options** page contains the following elements:

- The **Fit To Screen** button displays the entire run on the run graph page.
- The **Auto Scroll** button displays the last 10 minutes of the historical run or the run in progress, and cannot be scrolled back.

- The **Manual Scroll** button displays the last 10 minutes of the run, with a scroll bar beneath the run graph to scroll through the entire run.
- Select the **Cancel** button to discard your changes and return to the previous page.
- Select the **OK** button to accept your changes and return to the previous page.

Run History Page

Figure 8.27 Run History Page

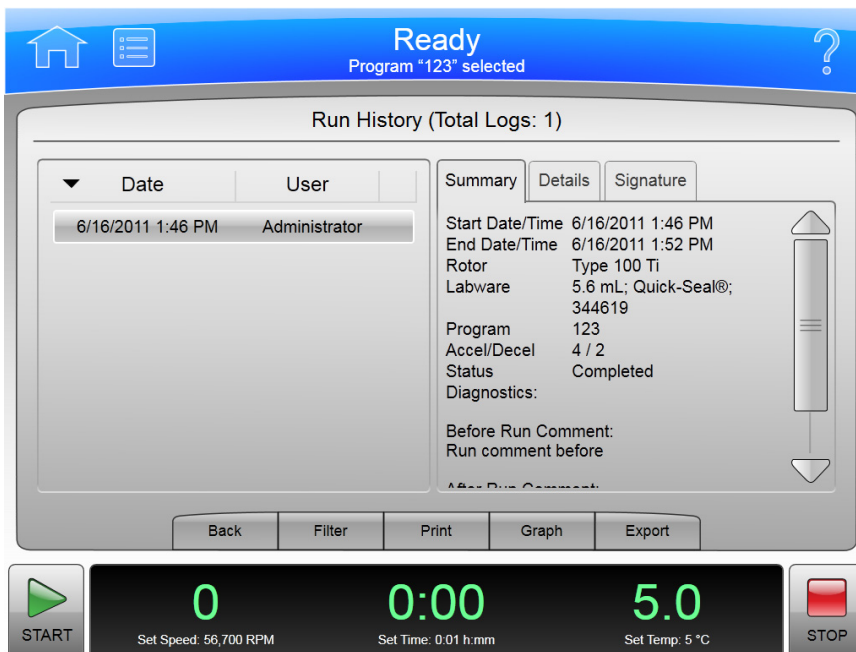
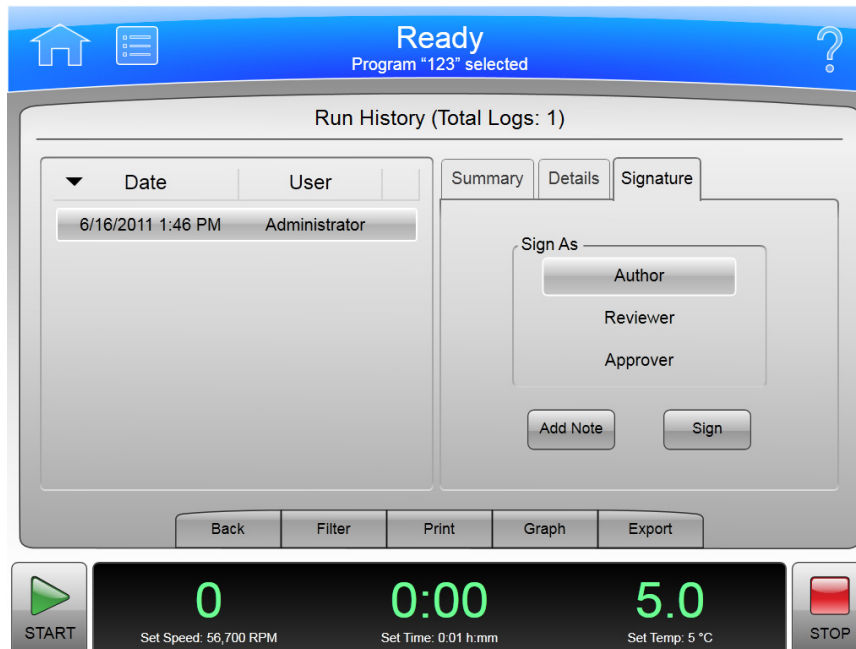


Figure 8.28 Run History Page (E-Signature Enabled)

Select the **Run History** button on the side menu of the [Home Page](#) to display the **Run History** page.

Figure 8.29 Run History Button

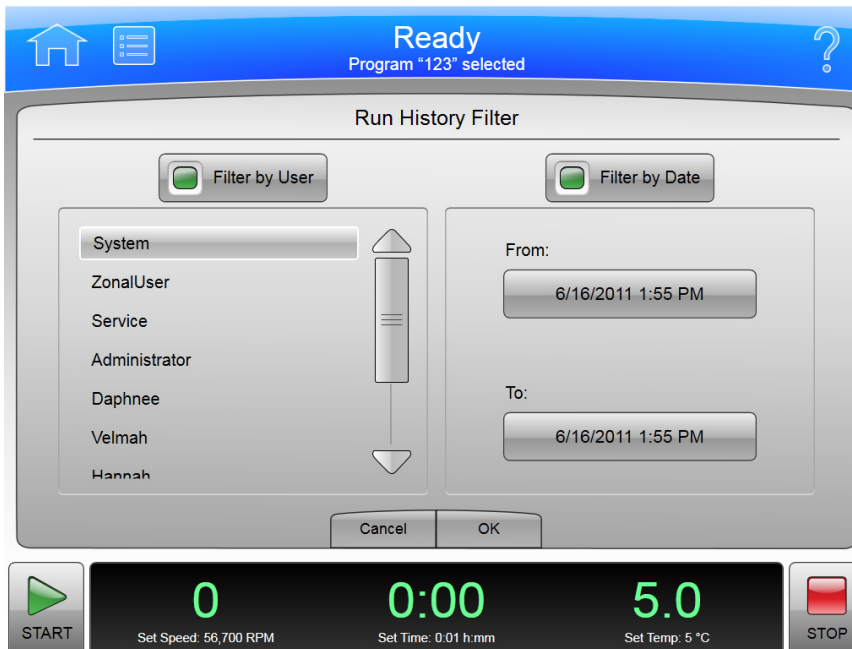
In addition to the Header Bar and the Footer Bar, the **Run History** page contains the following elements:

- The run logs for all instrument runs are listed on the left. Select a run log to review.
- The Summary tab shows summary details for the selected run.
- The Details tab shows detailed information for each step of the selected run.
- If your system has E-Signature enabled (see [The Reports Tab](#)), use the Signature tab to sign off on the run as the Author, Reviewer, or Approver. You must select a role to enable the **Add Note** and **Sign** buttons. Active options are determined by your user level. The Signature tab contains the following elements:
 - Select **Author** to sign the run log as the author.
 - Select **Reviewer** to sign the run log as the reviewer.
 - Select **Approver** to sign the run log as the approver.
 - You can optionally select **Add Note** to display the **Add Note** page. Enter your note and select **Sign** to display the **Sign** page. Enter your PIN and select **OK** to sign the run and display the **Run History** page.
 - Select **Sign** to display the **Sign** page. Enter your PIN and select **OK** to sign the run and display the **Run History** page.
- The **Back** button returns to the previous page.

- The **Filter** button displays the [Run History Filter Page](#).
- The **Print** button prints all the listed run logs. (Use **Filter** to narrow the list.)
- The **Graph** button displays the [Historical Run Data Page](#) for the selected run log.
- The **Export** button exports all the listed run logs. (Use **Filter** to narrow the list.) The system displays the **Export** page.

Run History Filter Page

Figure 8.30 Run History Filter Page



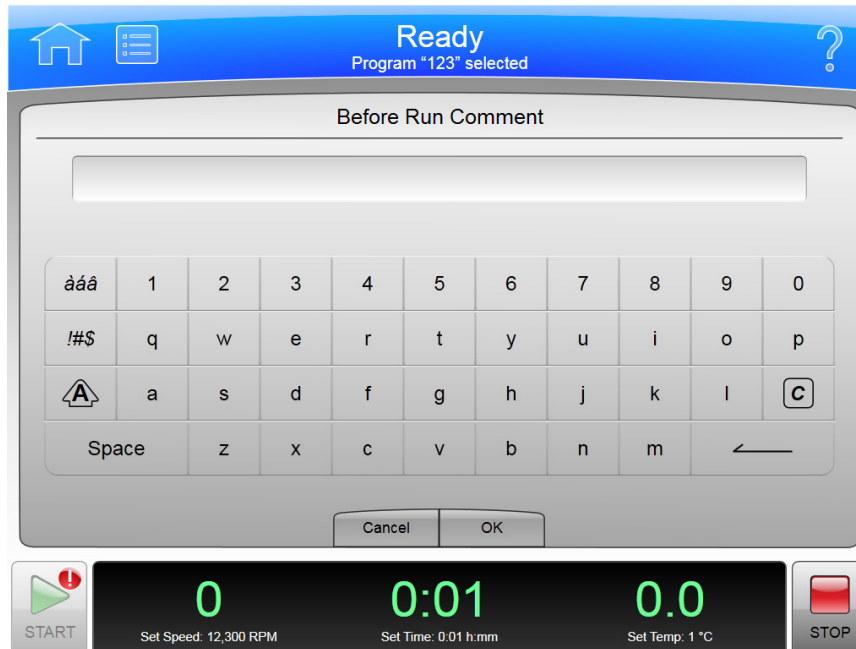
Select the **Filter** button on the [Run History Page](#) to display the **Run History Filter** page. Use this page to narrow the parameters for the run logs that will be displayed, printed or exported on the [Run History Page](#).

In addition to the Header Bar and the Footer Bar, the **Run History Filter** page contains the following elements:

- The **Filter by User** button enables the user list. Select a user from the list to limit the run log display to the runs performed by the selected user.
- The **Filter by Date** button enables the From and To fields. Select the fields to display the Set Date pages and enter a date range to which to limit the run log display.
- Select the **Cancel** button to discard your entries and return to the [Run History Page](#).
- Select the **OK** button to accept your entries and return to the [Run History Page](#).

Before Run/After Run Comment Page

Figure 8.31 Before Run Comment Page



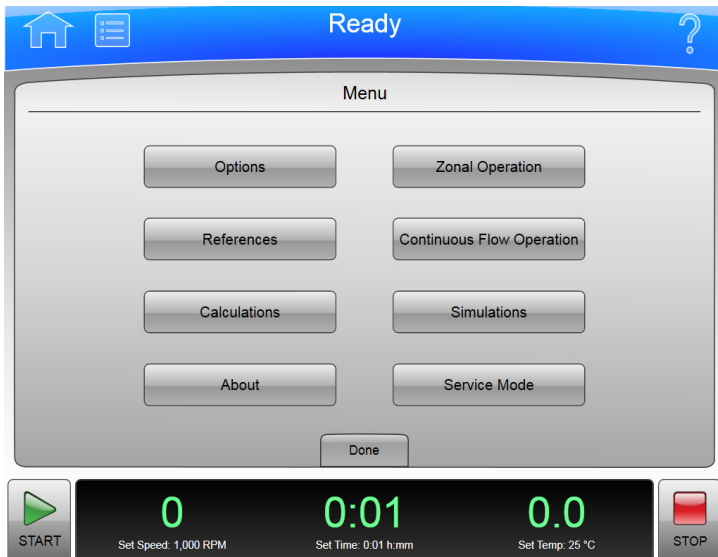
If your system has Run Comments enabled (see [The Reports Tab](#)), it displays the **Before Run Comment** page when you start a run, and the **After Run Comment** page when a run ends.

In addition to the Header Bar and the Footer Bar, the Run Comment pages contains the following elements:

- Use the Keypad to enter your comment.
- The **Cancel** button discards your comment and dismisses the page.
- The **OK** button accepts your comment and dismisses the page.

Menu Page

Figure 8.32 Menu Page

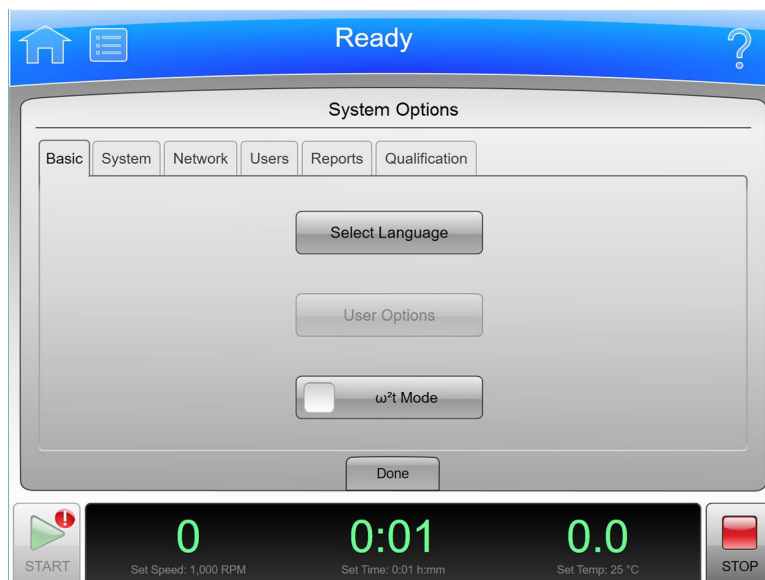


Select the **Menu** button in the Header Bar to display the **Menu** page. Use this page to configure or use XPN options.

- The **Options** button displays the [System Options Page](#).
- The **References** button displays the [References Page](#).
- The **Calculations** button displays the [Calculations Page](#).
- The **About** button displays the [About Page](#).
- The **Zonal Operation** button displays the [Zonal Authorization Page](#).
- The **Continuous Flow Operation** button displays the [Continuous Flow Authorization Page](#).
- The **Simulations** button displays the [Simulations Page](#).
- The **Service Mode** button is used by service personnel only. If you select this button and display the **Service Login** page, select the **Cancel** button to dismiss the page.
- The **Done** button dismisses the page.

System Options Page

Figure 8.33 System Options Page, Basic Tab



Select the **Options** button in the **Menu** page to display the **System Options** page (Figure 8.33). Use this page to configure the system option settings.

The System Options page is organized into five tabs. If you have user login enabled, many of the options are restricted to Admin-level users. (See the [Manage Users Page](#) for more information.) If a button is greyed out, you do not have access to the option.

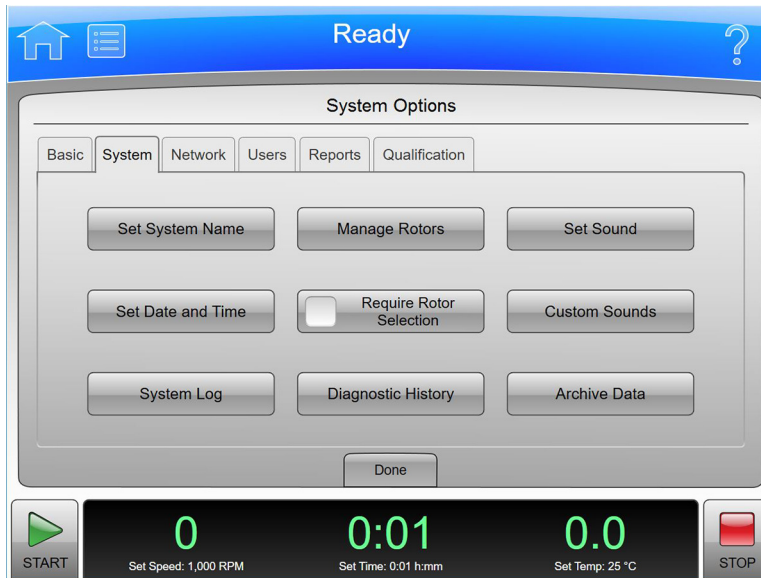
In addition to the Header Bar and the Footer Bar, the **System Options** page contains the following elements organized on five tabs:

The Basic Tab

- The **Select Language** button (Figure 8.33) displays the [Select Language Page](#).
- The **User Options** button displays the [User Options Page](#).
- The **ω²t Mode** button enables and disables the ω²t mode. The mode is on when the green square is visible. See the [Set Speed ω²t Time Page](#) for details.

The System Tab

Figure 8.34 System Options Page, System Tab



- The **Set System Name** button displays the **Set System Name** page. Enter the system name and select OK to return to the **System Options** page (Figure 8.34).
- The **Set Date and Time** button displays the [Set Date and Time Page](#).
- The **System Log** button displays the [System Log Page](#).
- The **Manage Rotors** button displays the [Manage Rotors Page](#).
- The **Require Rotor Selection** button enables and disables the requirement to select a rotor from the rotor library before you can start a run.
- The **Diagnostic History** button displays the [Diagnostic History Page](#).
- The **Set Sound** button displays the [Set Sound Page](#).
- The **Custom Sounds** button displays the [Custom Sounds Page](#).
- The **Archive Data** button displays the [Archive Data Page](#).

The Network Tab

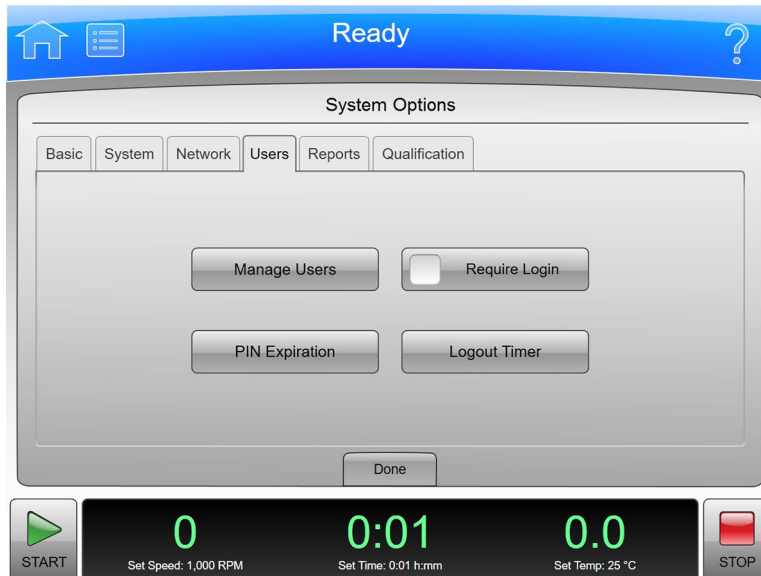
Figure 8.35 System Options Page, Network Tab



- The **Setup Network** button displays the [Setup Network Page](#).
- The **Select Printer** button displays the [Select Printer Page](#).
- The **Setup Email** button displays the [Setup Email Page](#).
- The **Setup Network Path** button displays the Setup Network Path Page.
- The **Setup VNC** button displays the [Setup VNC Page](#).
- The **Enable API** button enables and disables the Applications Programming Interface for remote devices. Contact your Beckman Coulter representative for more information.

The Users Tab

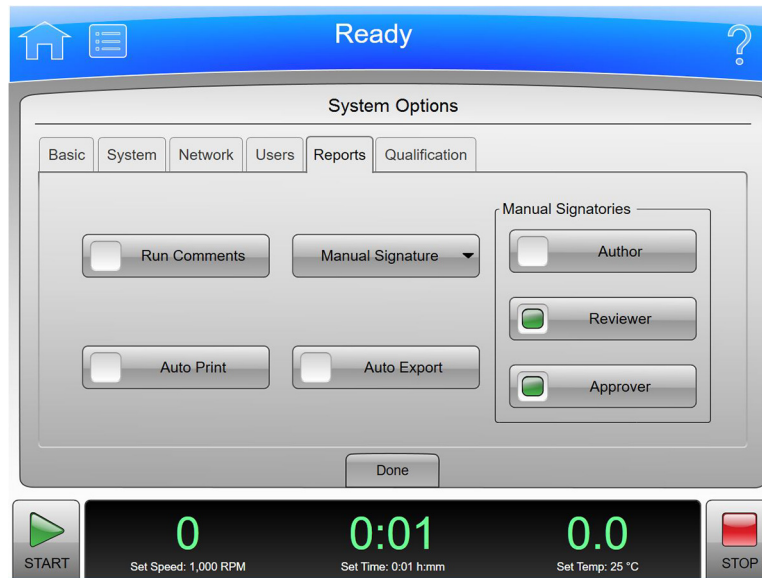
Figure 8.36 System Options Page, Users Tab



- The **Manage Users** button displays the [Manage Users Page](#).
- The **PIN Expiration** button displays the PIN Expiration page. Enter the number of days that you want PINs to remain valid. To disable PIN Expiration, enter **0** and select **OK** to return to the [System Options Page](#).
- The **Require Login** button enables and disables the user login requirement.
- The **Logout Timer** button displays the Logout Timer page. Change the field to the number of minutes of inactivity before the system logs out a user. To disable the Logout Timer, enter 0 and select **OK** to return to the [System Options Page](#).

The Reports Tab

Figure 8.37 System Options Page, Reports Tab



- The **Run Comments** button enables and disables the Before Run and After Run comment requirement.
- The **Manual Signature** drop down box allows choice of signature options. See [CHAPTER 4, Signature Options](#) for more information.
- The **Manual Signatories** buttons enable which signature lines will be included in a report when it is exported.
- The **Auto Print** button enables and disables automatic printing of run logs at the completion of each run. See [Auto Print and Auto Export Run History Data](#) for more information.
- The **Auto Export** button enables and disables automatic export of run logs at the completion of each run. See [Auto Print and Auto Export Run History Data](#) for more information.

The Qualification Tab

Figure 8.38 The Qualification Tab



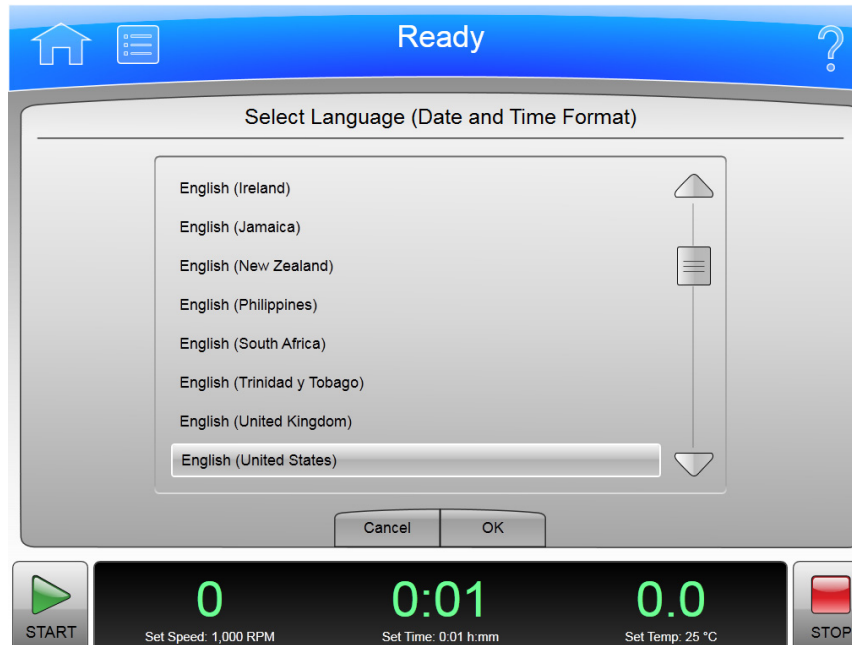
Optima XPN can provide instrument qualification status and the ability to enable a qualification alert.

NOTE You must have Administrator access to enter PQ dates and to enable the qualification alert.

- To enable alerts, select the **Manage** button to display the Qualification Management page. Select the **Enable Alerts** button. The small box in the **Enable Alerts** button will turn green to indicate that it is enabled. The Qualification Alert icon will be displayed at the top of the screen within 30 days of the re-qualification date and will continue to be displayed after the date. Operational Qualification Expiration Time Period can be selected as 6 months or 12 months.
- **Installation Qualification (IQ)** - Qualification at installation performed by a BCI Service Technician.
- **Operational Qualification (OQ)** - Certified qualification performed at either 6 or 12 month interval by a BCI Service Technician. [Contact us](#).
- **Performance Qualification (PQ)** - Workflow verification performed by a user lab at a user-selected interval.

Select Language Page

Figure 8.39 Select Language Page



Select the **Select Language** button on the Basic tab of the [System Options Page](#) to display the **Select Language** page. Use this page to choose the language and date, time and number format the instrument uses in operations.

In addition to the Header Bar and the Footer Bar, the **Select Language** page contains the following elements:

- The List of Languages shows all the languages and countries available for the instrument. Scroll through this list and select a language and country.
- The **Cancel** button discards your selection and returns to the [System Options Page](#).
- The **OK** button saves your selection and returns to the [System Options Page](#) with the newly-selected language active on all pages.

NOTE Be careful not to select a language that you do not understand. If you don't understand the display language, select the Menu button, then select the upper left button (Options), select the first tab (Basic), and then select the top button (Select Language).

User Options Page

Figure 8.40 User Options Page

The screenshot shows the 'User Options: Administrator' page. At the top, there is a blue header bar with a home icon, a menu icon, the word 'Ready', and a question mark icon. Below the header is a white box titled 'User Options: Administrator'. Inside this box are three input fields: 'PIN' (with four dots), 'Email', and 'Phone Number'. Below these fields are two buttons: 'Set Avatar' and 'Set Background'. At the bottom of the white box is a 'Done' button. Below the white box is a black footer bar with a green play button labeled 'START', three green digital displays showing '0', '0:01', and '0.0' with labels 'Set Speed: 1,000 RPM', 'Set Time: 0.01 h:mm', and 'Set Temp: 25 °C' respectively, and a red stop button labeled 'STOP'.

Select the **User Options** button on Basic tab of the [System Options Page](#) to display the **User Options** page. Use this page to configure personal options and information for your User ID on the XPN.

NOTE You can display this page only if Require Login is enabled (see [The Users Tab](#)).

In addition to the Header Bar and the Footer Bar, the **User Options** page contains the following elements:

- Select **PIN** to display the [Reset User PIN Page](#).
- Select **Email** to display the Enter Email page. If your system is configured for email, it will send all diagnostic messages to the address you enter. Select **Save** to return to the User Options page.
- Select **Phone Number** to display the Enter Phone Number page. Enter your phone number and select **Save** to return to the User Options page.
- Select the **Set Avatar** button to select or import an image to appear in the Footer Bar of the Home page when you are logged on. The system displays the [Select Image Page](#).
- Select the **Set Background** button to select or import an image to appear as the background in the Footer Bar of the Home page when you are logged on. The system displays the [Select Image Page](#).
- The **Done** button dismisses the page.

Reset User PIN Page

Figure 8.41 Reset User PIN Page

The screenshot shows a control panel interface. At the top, a blue header bar contains a home icon, a menu icon, the word "Ready", and a question mark icon. Below this, the main content area is titled "Reset User PIN: Administrator". It contains three input fields: "Enter PIN" (with three green dots), "Enter new PIN" (with three green dots), and "Confirm new PIN" (with three black dots). Below the input fields is a numeric keypad with buttons for digits 1-9, 0, a "Clear" button, and a back arrow. At the bottom of the keypad area are "Cancel" and "Save" buttons. The footer bar is black and contains a green "START" button, three green digital displays showing "0", "0:01", and "0.0", and a red "STOP" button. Below the displays are labels: "Set Speed: 1,000 RPM", "Set Time: 0:01 h:mm", and "Set Temp: 25 °C".

Select the **PIN** field on the [User Options Page](#) to display the **Reset User PIN** page. Use this page to change the PIN for your user ID.

In addition to the Header Bar and the Footer Bar, the **Reset User PIN** page contains the following elements:

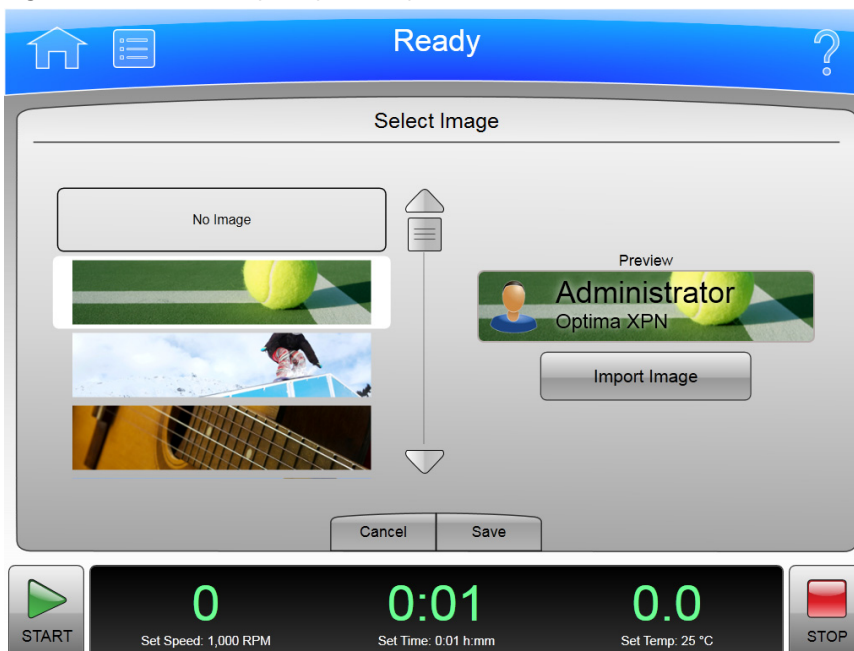
- Enter your current PIN in the **Enter PIN** field.
- Enter your new PIN in the **Enter new PIN** field.
- Enter the same PIN in the **Confirm new PIN** field.
- Select the **Cancel** button to discard your changes and return to the [User Options Page](#).
- Select the **Save** button to save your changes and return to the [User Options Page](#).

Select Image Page

Figure 8.42 Select Image Page (Avatar)



Figure 8.43 Select Image Page (Background)



Select the **Set Avatar** button or the **Set Background** button on the [User Options Page](#) to display the **Select Image** page. Use this page to select or import an avatar or background for your user ID on the XPN.

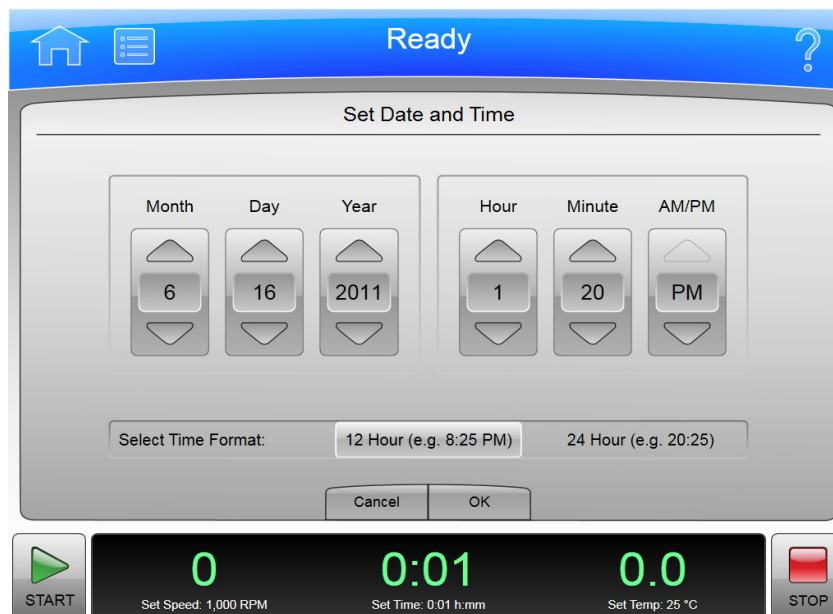
In addition to the Header Bar and the Footer Bar, the **Select Image** page contains the following elements:

- The Image list shows all the available avatar or background images.
- Select **Import Image** to import an image from a network drive or USB device. The system displays the [Import Page](#).
- Select the **Cancel** button to discard your changes and return to the [User Options Page](#).
- Select the **Save** button to save your changes and return to the [User Options Page](#).

NOTE The system supports .jpg and .png file formats. Images must be less than 50 KB.

Set Date and Time Page

Figure 8.44 Set Date and Time Page



Select the **Set Date and Time** button on System tab of the [System Options Page](#) to display the **Set Date and Time** page. Use this page to set the instrument's internal time and date.

In addition to the Header Bar and the Footer Bar, the **Set Date and Time** page contains the following elements:

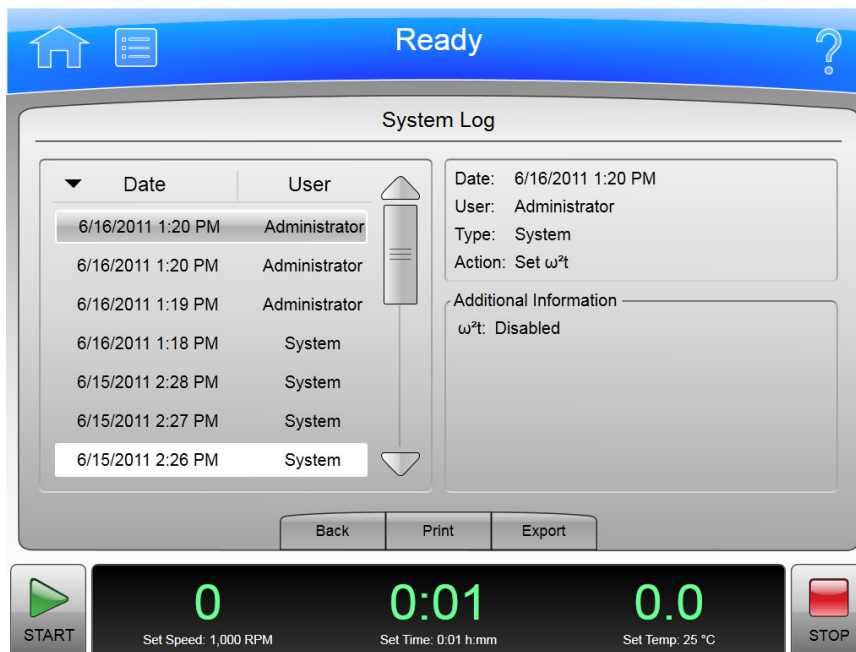
- The Month-Day-Year controls set the date. Select the arrow buttons to increase or decrease the numbers.
- The Hour-Minute-AM/PM controls set the time. The AM/PM value has only one arrow button enabled at a time.
- The **Select Time Format** buttons set the time format. The 12 Hour format button displays a 12 hour clock with AM and PM. The 24 Hour format button displays a 24 hour clock without AM

and PM notation. With some language/country selections, the 12 hour option may be unavailable and the **Select Time Format** buttons will not be visible.

- The **Cancel** button discards your changes and returns to the [System Options Page](#).
- The **OK** button accepts your changes and returns to the [System Options Page](#).

System Log Page

Figure 8.45 System Log Page



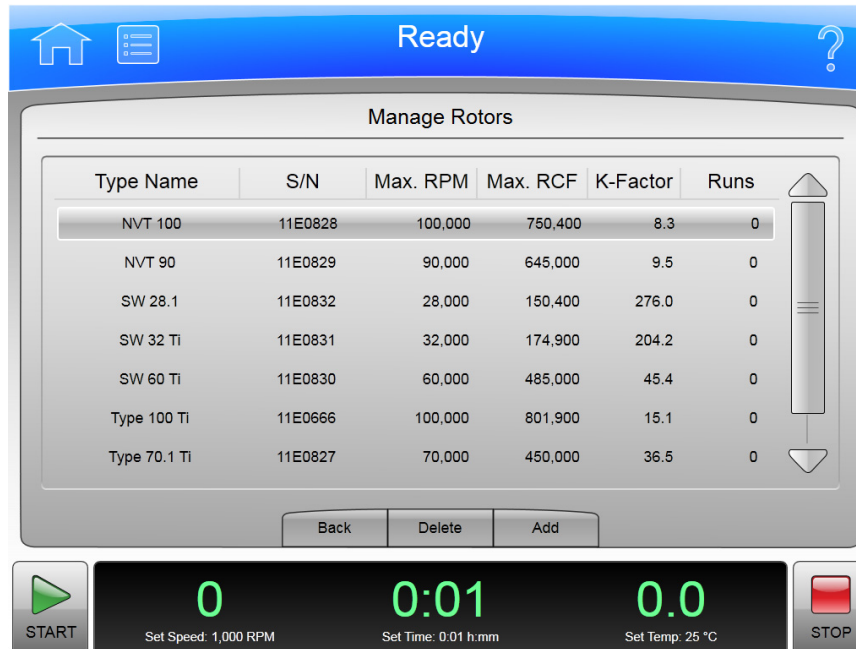
To display the history of changes to the system, select the **System Log** button on the System tab of the [System Options Page](#) to display the **System Log** page.

In addition to the Header Bar and the Footer Bar, the **System Log** page contains the following elements:

- The log entry list on the left lists the date and responsible user for each system option modified. Select an entry to display the details on the right.
- The Details section on the right shows detailed information for the selected event.
- Select the **Back** button to return to the [System Options Page](#).
- Select **Print** to print the system log.
- Select **Export** to export the system log. The system displays the [Export Page](#).

Manage Rotors Page

Figure 8.46 Manage Rotors Page



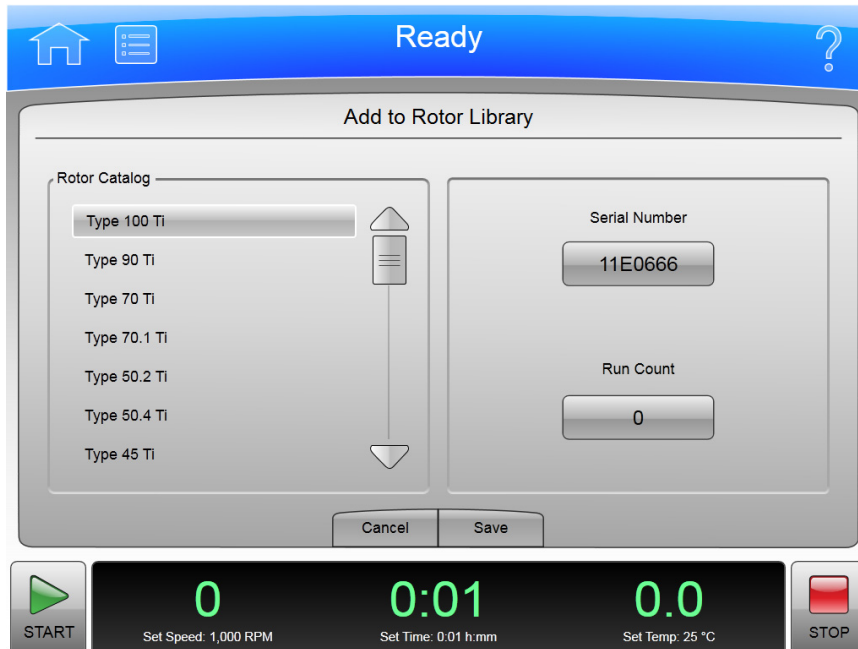
To add or delete rotors from your rotor library, select the **Manage Rotors** button on the System tab of the [System Options Page](#) to display the **Manage Rotors** page. See [Managing Rotors](#) for more information.

In addition to the Header Bar and the Footer Bar, the **Manage Rotors** page contains the following elements:

- The rotor list displays the rotors that have been added to the library.
- Select the **Back** button to return to the [System Options Page](#).
- Select a rotor and select **Delete** to delete the rotor. The system displays a confirmation message. Select **Yes** to delete the rotor.
- Select **Add** to add a rotor to the library. The system displays the [Add to Rotor Library Page](#).

Add to Rotor Library Page

Figure 8.47 Add to Rotor Library Page



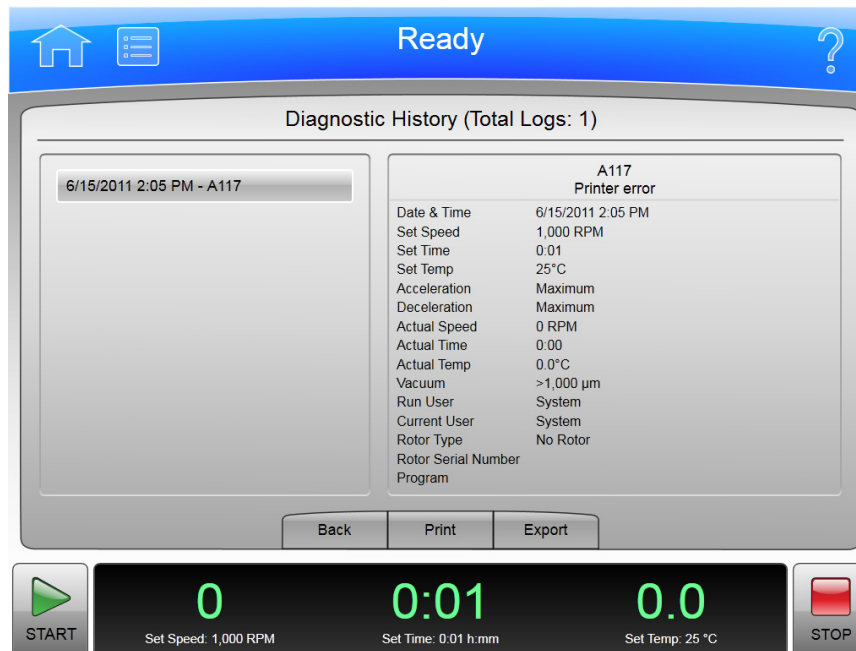
To add a rotor to your rotor library, select the **Add** button on the [Manage Rotors Page](#) to display the **Add to Rotor Library** page.

In addition to the Header Bar and the Footer Bar, the **Add to Rotor Library** page contains the following elements:

- The Rotor Catalog list on the left lists all the rotors that are compatible with the instrument. Select the type of rotor to add to the library.
- Select the **Serial Number** field to display the **Enter Serial Number** page. Enter the rotor serial number and select **OK** to return to the **Add to Rotor Library** page.
- Select the **Run Count** field to display the **Run Count** page. Enter the number of times the rotor has been used and select **OK** to return to the **Add to Rotor Library** page.
- The **Cancel** button discards your entry and returns to the [Manage Rotors Page](#).
- The **Save** button accepts your entry and returns to the [Manage Rotors Page](#).

Diagnostic History Page

Figure 8.48 Diagnostic History Page



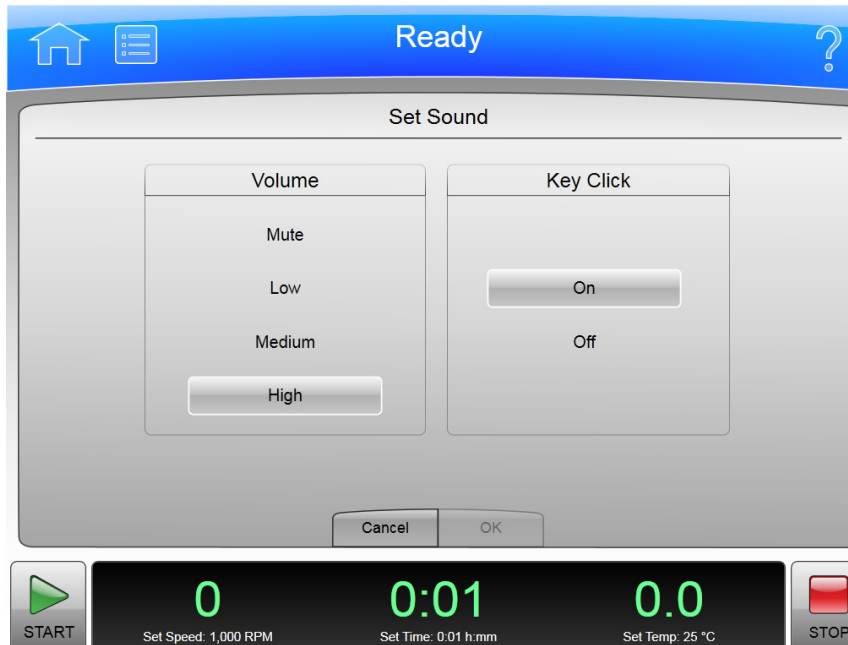
Select the **Diagnostic History** button on the System tab of the [System Options Page](#) to display the **Diagnostic History** page. Use this page to review and export the details of incidents that caused a diagnostic message on the instrument (warnings and error messages).

In addition to the Header Bar and the Footer Bar, the **Diagnostic History** page contains the following elements:

- The List of Events on the left side of the screen shows all the diagnostic events for the instrument. Scroll through this list and select an event to view the detailed information about it.
- The Event Details on the right side of the screen shows detailed information for the selected event.
- The **Back** button returns to the [System Options Page](#).
- The **Print** button prints the entire diagnostic history.
- Select **Export** to export the entire diagnostic history. The system displays the [Export Page](#).

Set Sound Page

Figure 8.49 Set Sound Page



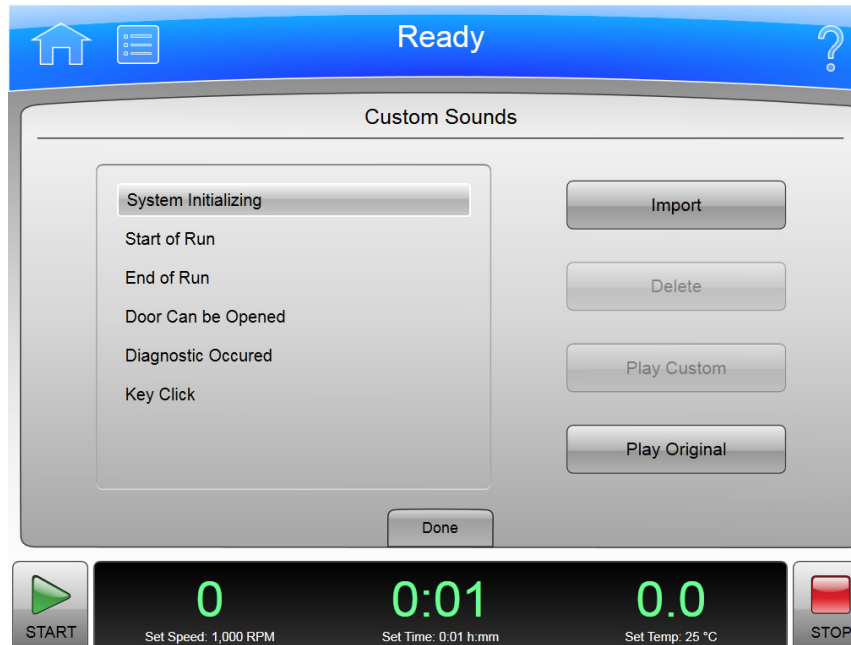
Select the **Set Sound** button on the System tab of the [System Options Page](#) to display the **Set Sound** page. Use this page to set the volume and enable or disable the key click option.

In addition to the Header Bar and the Footer Bar, the **Set Sound** page contains the following elements:

- The **Volume** buttons determines one of the four system volumes: Mute (silent), Low, Medium, or High.
- The **Key Click** buttons set the key click (an audible sound for every screen touch) On or Off.
- The **Cancel** button discards your changes and returns to the [System Options Page](#).
- The **OK** button accepts your changes and returns to the [System Options Page](#).

Custom Sounds Page

Figure 8.50 Custom Sounds Page



Select the **Custom Sounds** button on the System tab of the [System Options Page](#) to display the **Custom Sounds** page. Use this page to import custom sounds for various system events. See [Audible Sounds](#) for more information.

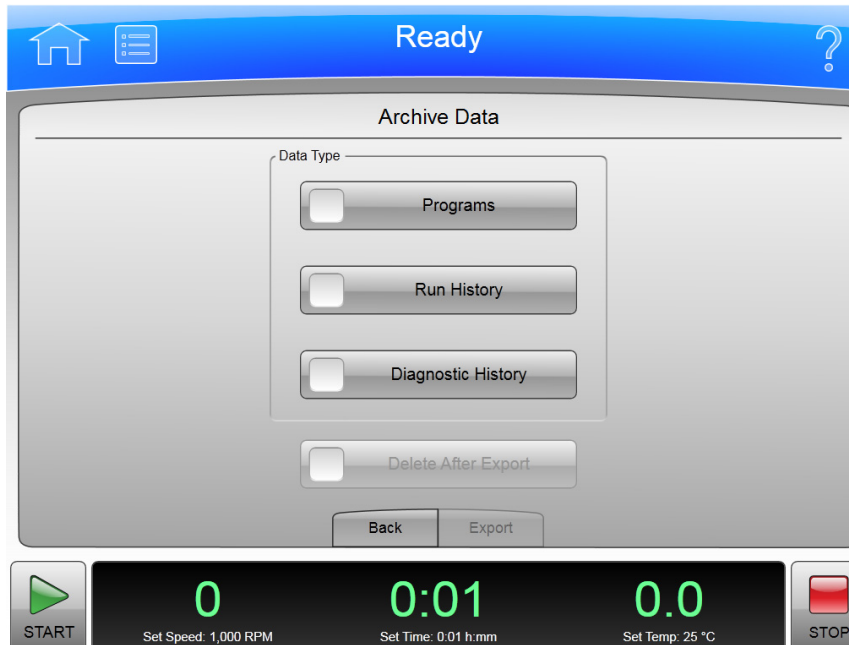
NOTE Sounds have a 10-second play limit. Files much larger than this may not be imported.

In addition to the Header Bar and the Footer Bar, the **Custom Sounds** page contains the following elements:

- The system sound list shows the system events with audible notices. Select an event to review or change the associated sound.
- Select **Import** to import a sound for the selected event from a network drive or USB device. The system displays the [Import Page](#).
- Select **Delete** to delete the sound associated with the selected event. The system displays a confirmation message. Select **Yes** to delete the sound.
- Select **Play Custom** to play the custom sound associated with the selected event.
- Select **Play Original** to play the original sound associated with the selected event.
- Select the Done button to return to the [System Options Page](#).

Archive Data Page

Figure 8.51 Archive Data Page



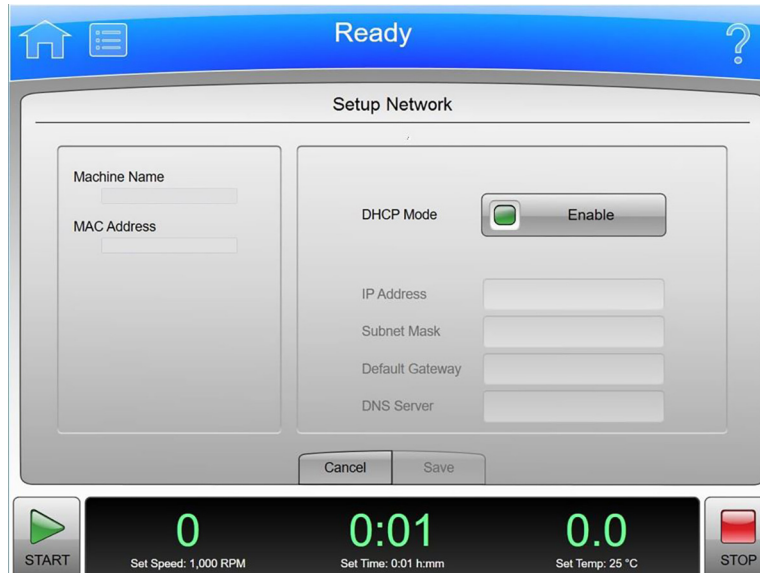
Select the **Archive Data** button on the System tab of the [System Options Page](#) to display the **Archive Data** page. Use this page to configure export of different types of system information.

NOTE Run History and Diagnostic History cannot be imported back into the system.

- The **Programs** button enables and disables run program export.
- The **Run History** button enables and disables export of run logs.
- The **Diagnostic History** button enables and disables the export of diagnostic messages.
- The **Delete After Export** button is available only when you select all three data types. Select the button to delete the information after it has been exported.
- The **Back** button returns to the [System Options Page](#).
- Select **Export** to export the selected information. The system displays the [Export Page](#).

Setup Network Page

Figure 8.52 Setup Network Page



Select the **Setup Network** button on Network tab of the [System Options Page](#) to display the **Setup Network** page (Figure 8.52). Use this page to configure the network connection.

In addition to the Header Bar and the Footer Bar, the **Setup Network** page contains the following elements:

- **DHCP Mode** (Dynamic Host Configuration Protocol) is enabled by default and automatically uses a DHCP Server on the network to retrieve IP address values. If your network administrator provides a specific IP address, disable DHCP mode and enter the values provided for the following fields:
 - **IP Address**
 - **Subnet Mask**
 - **Default Gateway**
 - **DNS Server**
- The **Cancel** button discards your changes and returns to the [System Options Page](#).
- The **Save** button accepts your changes and returns to the [System Options Page](#).

Setup Network Path

Figure 8.53 Setup Network Path

The screenshot shows a touch-screen interface for configuring network settings. At the top, a blue bar displays 'Ready' and a home icon. Below this, the 'Setup Network Path' window is open, featuring four text input fields for 'Network Path', 'User Name', 'Password', and 'Domain'. A 'Test Network Path' button is positioned below the password field. At the bottom of the window are 'Cancel' and 'Save' buttons. The device's footer bar includes a green 'START' button, a red 'STOP' button, and three digital readouts: '0' for Set Speed (1,000 RPM), '0:01' for Set Time (0:01 h:mm), and '0.0' for Set Temp (25 °C).

Select the **Setup Network Path** button on the **Network** tab of the *System Options Page* to display the **Setup Network Path** page. Use the page to configure the network path access.

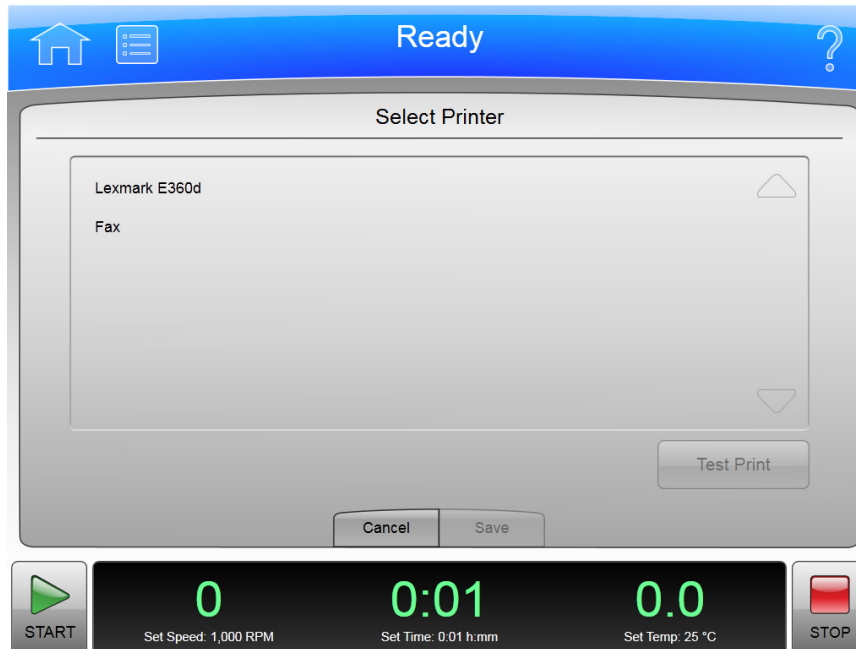
Some features of this instrument can support a GMP workflow with the proper network. Refer to *Optima XPN Series and Avanti JXN Series Recommended Networking Configurations Guide (C67730)* for details. Consult with your local IT department to ensure that privacy and security requirements are met.

In addition to the Header Bar and Footer Bar, the **Setup Network Path** page contains the following elements:

- **Network path** — the instrument automatically uses for import and export. Select the **Network Path** field to display the Network Path page and enter the base network path for import and export. This should be a UNC path (e.g., \\server\sharename\folder). Select **OK** to return to the **Setup Network Path** page.
- **User Name** — the user name used to authenticate to the server for the **Network Path**.
- **Password** — the password used to authenticate to the server for the **Network Path**.
- **Domain** — *Field is Optional*. If specified, the domain is used to authenticate to the server for the **Network Path**.
- **Cancel** — discards your changes and returns to the *System Options Page*.
- **Save** — accepts your changes and returns to the *System Options Page*.

Select Printer Page

Figure 8.54 Select Printer Page



To select a printer for the system, select the **Select Printer** button on the Network tab of the **System Options Page** to display the Select Printer page.

In addition to the Header Bar and the Footer Bar, the **Select Printer** page contains the following elements:

- The Printer list shows the configured printers on the network or physically connected to the instrument. Printers must be configured by Beckman Coulter Field Service. Select the printer to use.
- You can select **Test Print** to send a test page to the selected printer.
- The **Cancel** button discards your selection and returns to the **System Options Page**.
- The **Save** button accepts your selection and returns to the **System Options Page**.

Setup Email Page

Figure 8.55 Setup Email Page

The screenshot shows the 'Setup Email' configuration page. The header bar is blue and contains a home icon, a menu icon, the word 'Ready', and a question mark icon. The main content area is titled 'Setup Email' and contains several input fields: 'SMTP Server' (BCI), 'Port Number' (25), 'User Name' (empty), 'Password' (masked with dots), and 'Email From' (Do.Not.Reply@optima.beckmancoulter.com). There is an 'SSL Server' section with an 'Enable' button (currently disabled) and a 'Test Email' button. At the bottom of the form are 'Cancel' and 'Save' buttons. Below the form is a footer bar with a 'START' button, three digital displays showing '0', '0:01', and '0.0' with labels 'Set Speed: 1,000 RPM', 'Set Time: 0.01 h:mm', and 'Set Temp: 25 °C', and a 'STOP' button.

Select the **Setup Email** button on the Network tab of the [System Options Page](#) to display the **Setup Email** page. Use this page to configure settings for email sent from the instrument. When email is configured, the instrument sends diagnostic notifications to all users with email addresses defined in their user profiles.

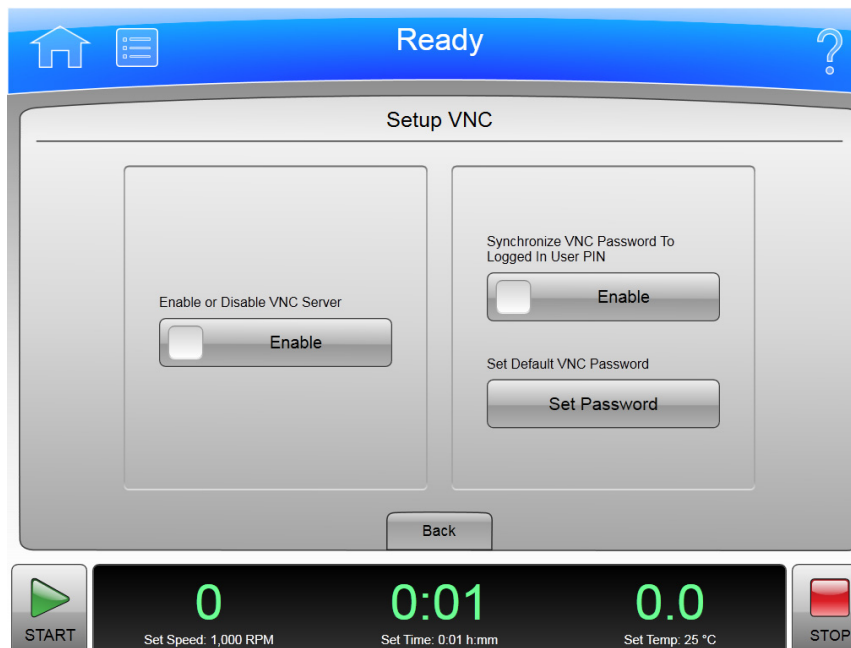
In addition to the Header Bar and the Footer Bar, the **Setup Email** page contains the following elements:

- Select the **SMTP Server** field to enter your email server name or address. Select **OK** to save the address and return to the Setup Email page.
- The **Port Number** field defaults to 25. Do not change it unless required by your email server.
- **User Name** and **Password** are optional, but may be required by your email server. Select the fields to enter the required values, then select **OK** to return to the Setup Email page.
- **Email From** defines the return email address that appears on email notifications sent by the instrument. You can change the default to a legitimate or fictitious address, depending on your requirements. Select the field to enter the new address, then select **OK** to save the address and return to the Setup Email page.
- Select the SSL Server **Enable** button to enable email encryption, if necessary. The button displays a green square when the option is enabled.
- You can select **Test Email** to send an email to test your configuration. Enter the recipient email address and select **OK** to send the email and return to the Setup Email page. The system displays a status message for the success or failure sending the test email. The email may still not be delivered to the specified recipient.
- The **Cancel** button discards your changes and returns to the [System Options Page](#).

- The **Save** button accepts your changes and returns to the [System Options Page](#).

Setup VNC Page

Figure 8.56 Setup VNC Page

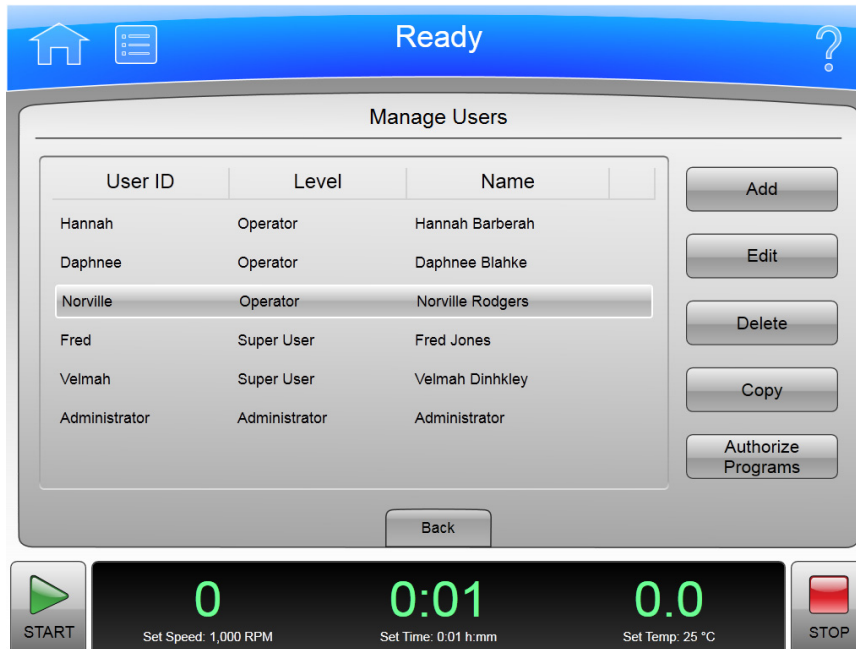


Select the Setup VNC button on the Network tab of the [System Options Page](#) to display the **Setup VNC** page. Use this page to connect to the instrument from a laptop or other remote device.

- The Enable or Disable VNC Server **Enable** button enables or disables the VNC server.
- The Synchronize VNC Password To Logged in User PIN **Enable** button enables or disables using the current user's PIN as the VNC password.
- Select the **Set Password** button to set a default password. Enter and confirm the password and select **OK** to save the password and return to the **Setup VNC** page. The system uses this password when no user is logged in.
- The **Back** button returns to the [System Options Page](#).

Manage Users Page

Figure 8.57 Manage Users Page



To add, delete or edit your users, select the **Program** button on the Users tab of the [System Options Page](#) to display the **Manage Users** page.

In addition to the Header Bar and the Footer Bar, the **Manage Users** page contains the following elements:

- Select **Add** to add a new user profile. The system displays the [Add User Page](#).
- Select a user ID and select **Edit** to change an existing user profile. The system displays the [Edit User Page](#).
- Select a user ID and select **Delete** to remove a user profile from the list. The system displays a confirmation message. Select **Yes** to remove the user profile. User IDs cannot be re-used.
- Select a user ID and select **Copy** to copy the user level and permissions from the selected user profile to a new user profile. This is helpful when you want to add a user with the same run program permissions as an existing user. The system displays the [Add User Page](#) with the copied information.
- Select an Operator-level user ID and select **Authorize Programs** to grant the user permission to use certain run programs. The system displays the [Authorize Programs Page](#).
- The **Back** button returns to the [System Options Page](#).

Add/Edit User Page

Figure 8.58 Add User Page

The screenshot shows the 'Add User' page. The header bar is blue and contains a home icon, the word 'Ready', and a question mark icon. The main area is titled 'Add User' and contains the following fields and buttons:

- User ID: Fred
- PIN: ****
- Email: fred.jones@mymail.com
- Full Name: Fred Jones
- Phone Number: 555-555-1212
- Select User Level: Operator, SuperUser, Administrator
- Buttons: Cancel, Save, Authorize Programs

The footer bar contains a START button, three digital displays (Set Speed: 1,000 RPM, Set Time: 0:01 h:mm, Set Temp: 25 °C), and a STOP button.

To add a user profile to the system, select the **Add** button on the [Manage Users Page](#) to display the **Add User** page.

To edit an existing user profile, select the user ID and select **Edit** on the [Manage Users Page](#) to display the **Edit User** page. The pages contain the same options.

In addition to the Header Bar and the Footer Bar, the **Add/Edit User** page contains the following elements:

- Select the **User ID** field to enter a user ID for a new user profile. Select **OK** to return to the Add User page.

NOTE Once you have saved the page, the User ID cannot be changed.

- Select the **PIN** field to set or change the PIN. Enter the new PIN in the **Enter PIN** field, and repeat the same number in the **Confirm PIN** field. Select **OK** to return to the **Add/Edit User** page.
- Select the **Email** field to enter or change the user's email. Enter or change the email address and select **OK** to return to the **Add/Edit User** page.

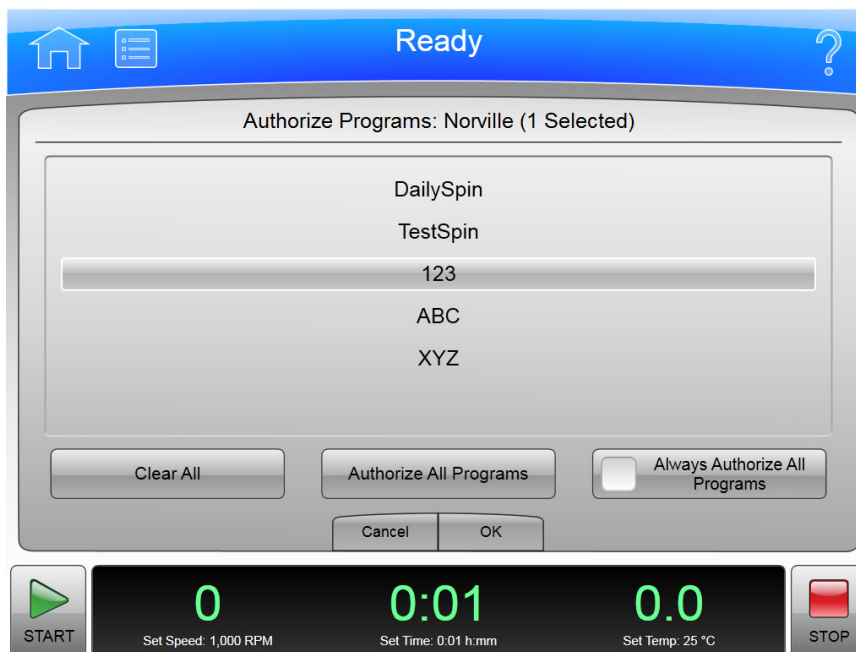
NOTE If the system is configured for email, all diagnostic messages will be sent to this address.

- Select the **Full Name** field to enter or change the name associated with this user profile. Enter or change the name and select **OK** to return to the **Add/Edit User** page.
- Select the **Phone Number** field to enter or change the user's phone number. Enter or change the phone number and select **OK** to return to the **Add/Edit User** page.
- Select the **User Level**. See [Managing Users](#) for more information.

- For Operator-level user profiles, you can select the **Authorize Programs** button to add permission to run programs to the user profile. The system displays the [Authorize Programs Page](#).
- The **Cancel** button discards your changes and returns to the [Manage Users Page](#).
- The **Save** button accepts your changes and returns to the [Manage Users Page](#).

Authorize Programs Page

Figure 8.59 Authorize Programs Page



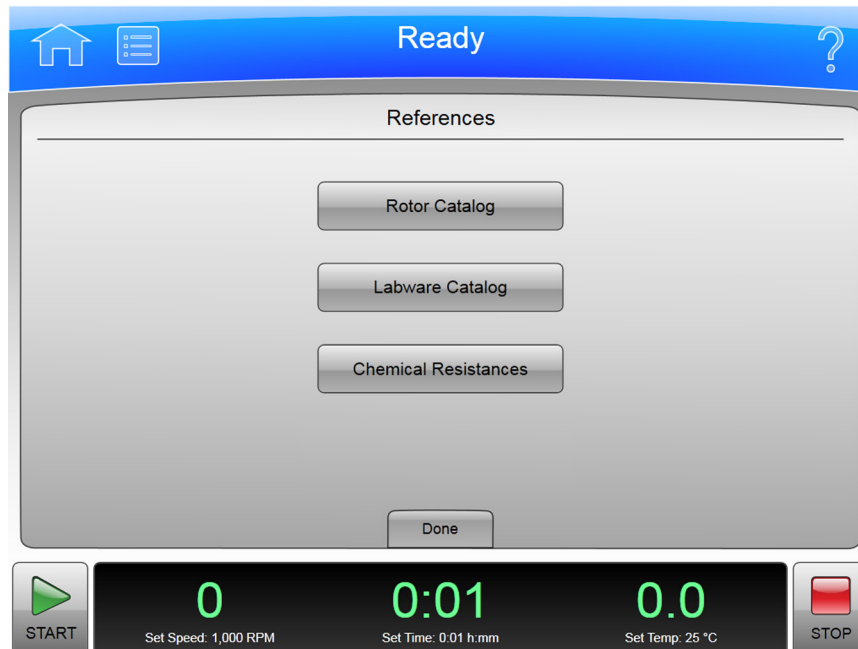
To manage the list of run programs the user has permission to run, select the user ID and select the **Authorize Programs** button on the [Manage Users Page](#), or select the **Authorize Programs** button on the [Add/Edit User Page](#) to display the **Authorize Programs** page.

In addition to the Header Bar and the Footer Bar, the **Authorize Programs** page contains:

- The User ID appears at the top of the page.
- The list box displays the programs in the system. Programs that the user has permission to run are highlighted.
- To grant the user permission to run additional programs, select the programs.
- To remove permission for all programs, select **Clear All**.
- To grant the user permission to run all programs, select **Authorize All Programs**.
- To grant the user permission to run all programs and all future programs as they are added to the system, enable **Always Authorize All Programs**.
- Select the **Cancel** button to discard your changes and return to the previous page.
- Select the **OK** button to accept your changes and return to the previous page.

References Page

Figure 8.60 References Page



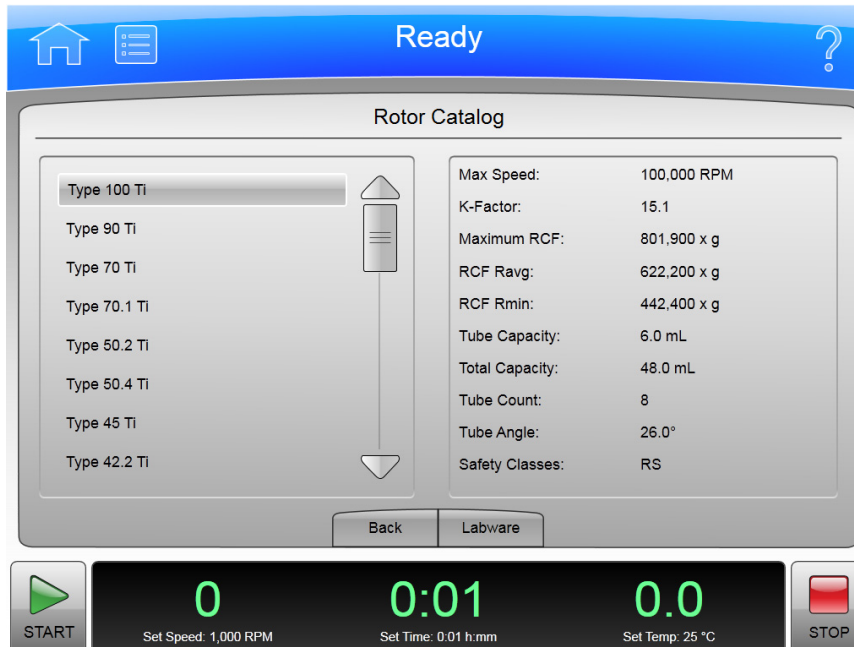
Select the **References** button in the [Menu Page](#) to display the **References** page. Use this page to view reference materials.

In addition to the Header Bar and the Footer Bar, the **References** page contains the following elements:

- The **Rotor Catalog** button displays the [Rotor Catalog Page](#).
- The **Labware Catalog** button displays the [Labware Catalog Page](#).
- The **Chemical Resistances** button displays the [Chemical Resistances Page](#).
- The **Done** button dismisses the page.

Rotor Catalog Page

Figure 8.61 Rotor Catalog Page



Select the **Rotor Catalog** button on the [References Page](#) to display the **Rotor Catalog** page. Use this page to examine the detailed specifications for all the rotors compatible with the XPN.

In addition to the Header Bar and the Footer Bar, the **Rotor Catalog** page contains the following elements:

- The rotor list on the left side of the screen shows compatible rotors. Scroll through this list and select a rotor to view the detailed information about it.
- The rotor details on the right side of the screen shows details for the selected rotor.
- The **Back** button returns to the **References** page.
- The **Labware** button displays the [Compatible Tubes for Rotor Page](#), which lists the labware available for the selected rotor. Note that this is a small subset of all the labware shown on the [Labware Catalog Page](#).

Compatible Tubes for Rotor Page

Figure 8.62 Compatible Tubes for Rotor Page



Select the **Labware** button on the [Rotor Catalog Page](#) to display the **Compatible Tubes for Rotor** page. Use this page to examine the detailed specifications for the labware for the selected rotor.

In addition to the Header Bar and the Footer Bar, the **Compatible Tubes for Rotor** page contains the following elements:

- The labware list on the left side of the screen shows labware for the selected rotor by volume, type, and part number. Scroll through this list and select an item to view the detailed information about it.

NOTE Under the "Type" field in the Labware list, some of the labware will have a -CF or -S suffix. The -CF suffix indicates the labware is Certified Free of various contaminants. The -S suffix indicates the labware is Sterilized in addition to being Certified Free of contaminants. Search the labware part number on www.beckman.com for more information.

- The labware details on the right side of the screen shows the details for the selected item.
- The **Back** button returns to the [Rotor Catalog Page](#).

Labware Catalog Page

Figure 8.63 Labware Catalog Page



Select the **Labware Catalog** button on the [References Page](#) to displays the **Labware Catalog** page. Use this page to examine the detailed specifications for labware available for the rotors your instrument can use.

In addition to the Header Bar and the Footer Bar, the **Labware Catalog** page contains the following elements:

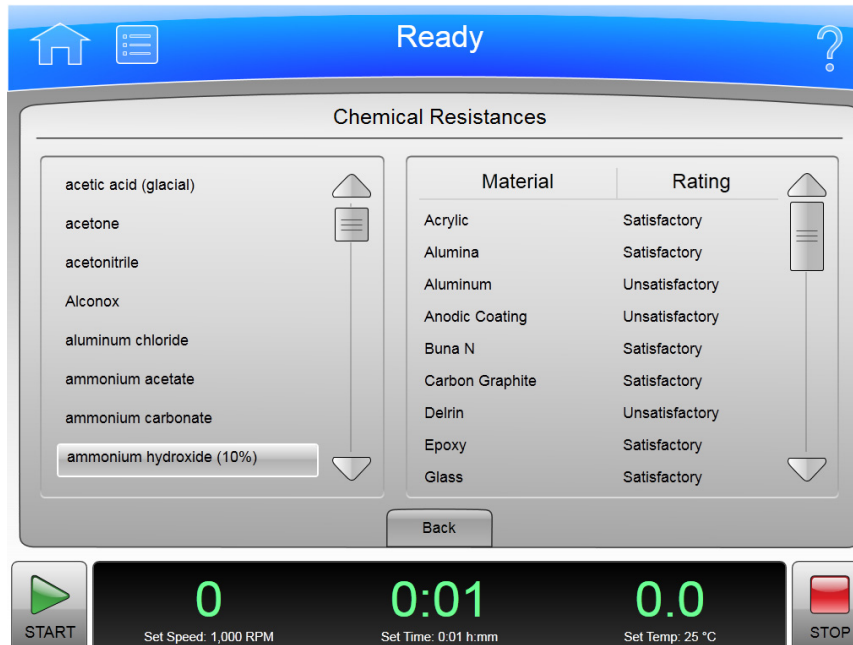
- The labware list on the left side of the screen shows labware by volume, type, and part number. Scroll through this list and select a particular item to review.

NOTE Under the **Type** field in the Labware list, some of the labware will have a -CF or -S suffix. The -CF suffix indicates the labware is Certified Free of various contaminants. The -S suffix indicates the labware is Sterilized in addition to being Certified Free of contaminants. Search the labware part number on www.beckman.com for more information.

- The labware details on the right side of the screen shows details for the selected item.
- The **Back** button returns to the [References Page](#).

Chemical Resistances Page

Figure 8.64 Chemical Resistance Page



Select the **Chemical Resistances** button on the [References Page](#) to displays the Chemical Resistances page. Use this page to examine general information about the chemical interaction between equipment and accessories used in ultracentrifugation and commonly used chemicals.

Equipment and accessory materials that have unsatisfactory or marginal resistance to the high concentrations used for these tests may still be usable in very low (that is, millimolar) concentrations. Reactions may vary under the stress of centrifugation, or with extended contact or temperature variations. Therefore, to prevent tube or bottle failure and sample loss, all solution/accessory combinations should be tested under operating conditions before use.

CAUTION

The information provided in the table is from current literature or research done by Beckman Coulter, and is only a guide for the proper selection of materials. No guarantee of safety, based on these recommendations, is expressed or implied. Many of the chemicals are explosive, toxic, caustic, allergenic, or carcinogenic. Always observe proper handling.

In addition to the Header Bar and the Footer Bar, the **Chemical Resistances** page contains the following elements:

- The chemical list on the left side of the screen shows commonly used chemicals. Scroll through this list and select a chemical to review.
- The material list on the right side of the screen shows materials commonly used in equipment and accessories, along with the chemical resistance rating for the selected chemical.
- The **Back** button returns to the [References Page](#).

Calculations Page

Figure 8.65 Calculations Page



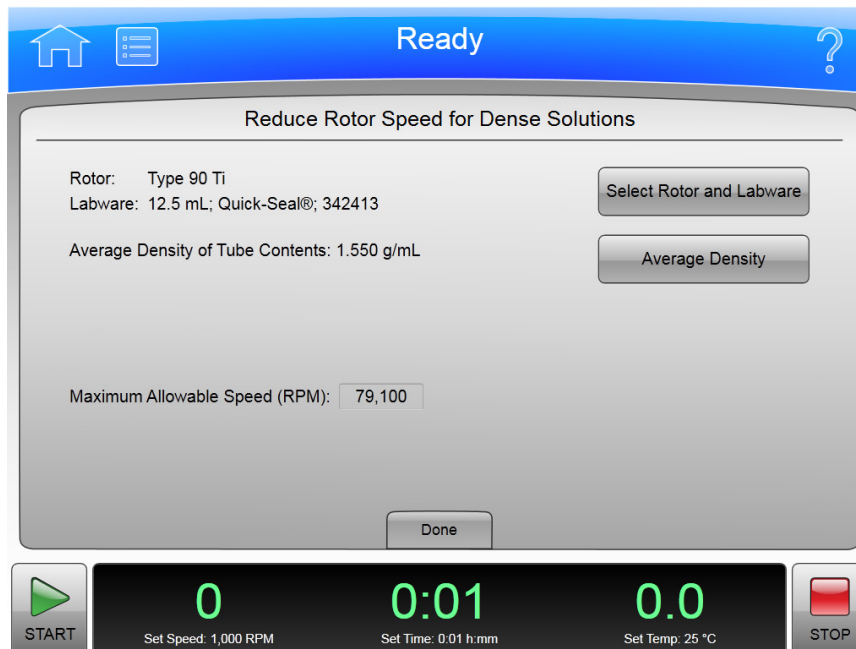
Select the **Calculations** button in the [Menu Page](#) to display the **Calculations** page. Use this page to perform a variety of calculations commonly used in ultracentrifugation. These calculations help simplify run preparation.

In addition to the Header Bar and the Footer Bar, the **Calculations** page contains the following elements:

- The **Reduce Rotor Speed** section includes buttons **For Dense Solutions** and **For Precipitating Solutions**, to calculate the reduced run speed required in these circumstances. See the [Reduce Rotor Speed for Dense Solutions Page](#) and the [Reduce Rotor Speed for Precipitating Solutions Page](#) for more information. Select the appropriate button to display the page for the calculation.
- The **Sedimentation Coefficient** section includes buttons **From Run Data** and **From Molecular Mass**. See the [Determine Sedimentation Coefficient from Run Data Page](#) and the [Determine Sedimentation Coefficient from Molecular Mass Page](#) for more information. Select the appropriate button to display the page for the calculation.
- The **Pelleting Time** button displays the [Calculate Pelleting Time Page](#).
- The **Concentration Measures** button displays the [Calculate Concentration Measures Page](#).
- The **Refractive Index** button displays the [Calculate Refractive Index Page](#).
- The **Done** button dismisses the page.

Reduce Rotor Speed for Dense Solutions Page

Figure 8.66 Reduce Rotor Speed for Dense Solutions Page



To display the **Reduce Rotor Speed for Dense Solutions** page, select the **For Dense Solutions** button on the [Calculations Page](#). Use this page to calculate the run speed required to centrifuge a solution with a density greater than the allowable density rating of the rotor (as listed in the applicable rotor manual), to protect the rotor from excessive stresses due to the added load.

In addition to the Header Bar and the Footer Bar, the Reduce Rotor Speed for Dense Solutions page contains the following elements:

- The **Select Rotor and Labware** button displays the [Select Rotor and Labware Page \(Catalog\)](#). Select the rotor and labware to use for the calculation and select **OK** to return to the Reduce Rotor Speed for Dense Solutions page.
- The **Average Density** button displays a numeric input page to set the density of the sample for the calculation. Enter the average density and select **OK** to perform the calculation and return to the Reduce Rotor Speed for Dense Solutions page.
- When you have entered the rotor and average density, the **Maximum Allowable Speed (RPM)** field displays the calculated speed.
- The **Done** button dismisses the page.

Reduce Rotor Speed for Precipitating Solutions Page

Figure 8.67 Reduce Rotor Speed for Precipitating Solutions Page

The screenshot shows a control panel interface for a centrifuge. At the top, a blue header bar contains a home icon, a menu icon, the word "Ready", and a help icon. Below this is a white box titled "Reduce Rotor Speed for Precipitating Solutions". Inside this box, the following information is displayed: "Rotor: Type 90 Ti", "Labware: 12.5 mL; Quick-Seal®; 342413", "Average Density of Tube Contents: 1.670 g/mL", and "Maximum Allowable Speed (RPM): 43,100". There are two buttons: "Select Rotor and Labware" and "Average Density". A "Done" button is located at the bottom of the white box. Below the white box is a black footer bar with a green "START" button, three digital displays showing "0", "0:01", and "0.0", and a red "STOP" button. The displays are labeled "Set Speed: 1,000 RPM", "Set Time: 0.01 h:mm", and "Set Temp: 25 °C" respectively.

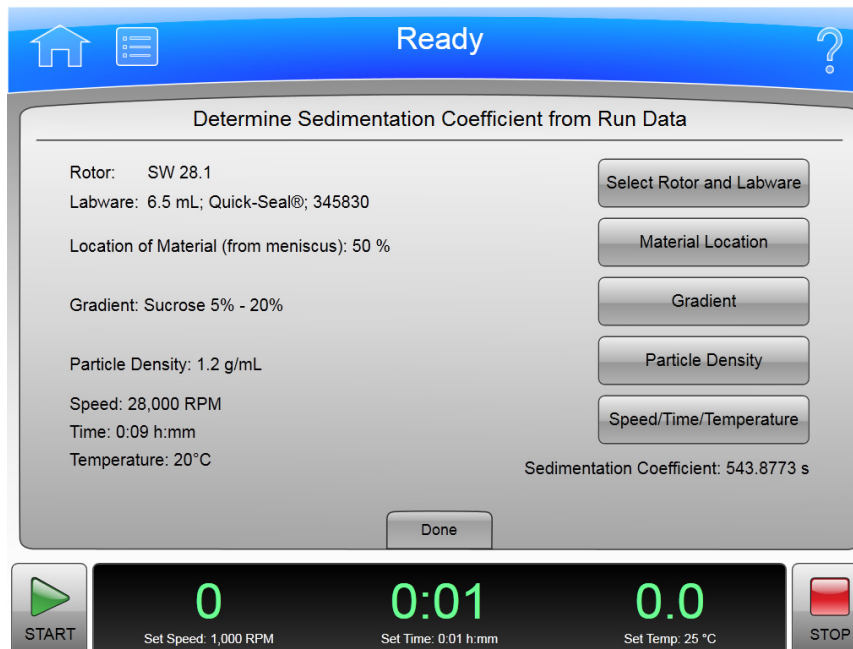
To display the **Reduce Rotor Speed for Precipitating Solutions** page, select the **For Precipitating Solutions** button on the [Calculations Page](#). Use this page to calculate the reduced run speed required to avoid precipitation of CsCl during centrifugation using concentrated CsCl solutions.

In addition to the Header Bar and the Footer Bar, the Reduce Rotor Speed for Precipitating Solutions page contains the following elements:

- The **Select Rotor and Labware** button displays the [Select Rotor and Labware Page \(Catalog\)](#). Select the rotor and labware to use for the calculation and select **OK** to return to the Reduce Rotor Speed for Precipitating Solutions page.
- The **Average Density** button displays a numeric input page to set the density of the sample for the calculation. Enter the average density and select **OK** to perform the calculation and return to the Reduce Rotor Speed for Precipitating Solutions page.
- When you have entered the rotor and average density, the **Maximum Allowable Speed (RPM)** field displays the calculated speed.
- The **Done** button dismisses the page.

Determine Sedimentation Coefficient from Run Data Page

Figure 8.68 Determine Sedimentation Coefficient from Run Data Page



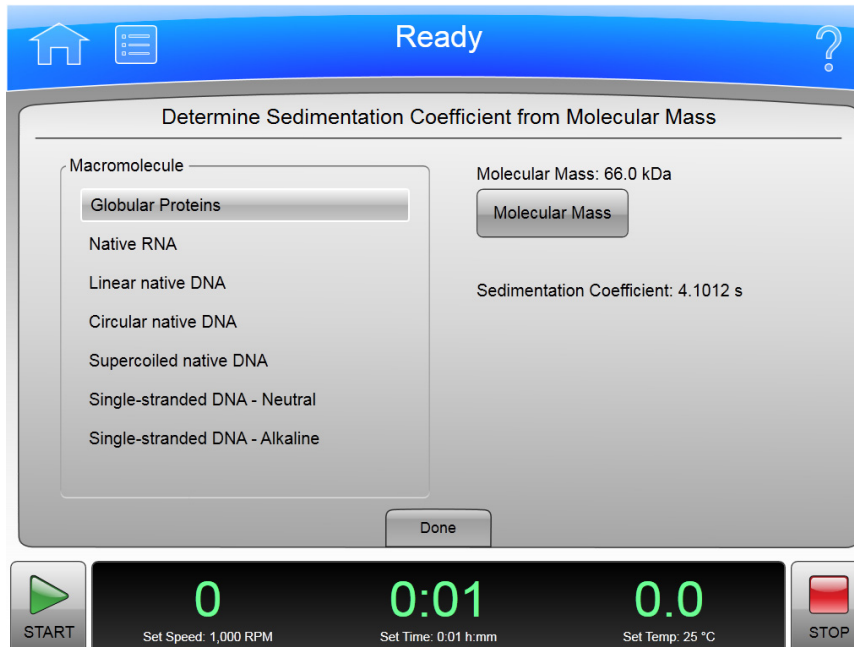
To calculate the sedimentation coefficient from provided run data, select the **From Run Data** button on the [Calculations Page](#) to display the **Determine Sedimentation Coefficient from Run Data** page. See [Sedimentation Coefficient From Run Data](#) for more information.

In addition to the Header Bar and the Footer Bar, the Determine Sedimentation Coefficient from Run Data page contains the following elements:

- The **Select Rotor and Labware** button displays the [Select Rotor and Labware Page \(Catalog\)](#). Select the rotor and labware to use for the calculation and select **OK** to return to the Determine Sedimentation Coefficient from Run Data page.
- The **Material Location** button displays the **Material Location** page to enter the location of the sample as the percentage down the tube from the meniscus. Enter the percentage and select **OK** to return to the Determine Sedimentation Coefficient from Run Data page.
- The **Gradient** button displays the **Select Gradient** page. Select or enter the sucrose concentration range and select **OK** to return to the Determine Sedimentation Coefficient from Run Data page.
- The **Particle Density** button displays the **Particle Density** page to enter the particle density. Enter the density and select **OK** to return to the Determine Sedimentation Coefficient from Run Data page.
- The **Speed/Time/Temperature** button displays the **Speed/Time/Temperature** page to enter the speed, time and temperature for the calculation. Enter a speed, time and temperature and select **OK** to perform the calculation and return to the Determine Sedimentation Coefficient from Run Data page.
- The **Sedimentation Coefficient** field displays the calculated sedimentation coefficient.
- The **Done** button dismisses the page.

Determine Sedimentation Coefficient from Molecular Mass Page

Figure 8.69 Determine Sedimentation Coefficient from Molecular Mass Page



To calculate the sedimentation coefficient from molecular mass, select the **From Molecular Mass** button on the [Calculations Page](#) to display the **Determine Sedimentation Coefficient from Molecular Mass** page. See [Sedimentation Coefficient From Molecular Mass](#) for more information.

In addition to the Header Bar and the Footer Bar, the Determine Sedimentation Coefficient from Molecular Mass page contains the following elements:

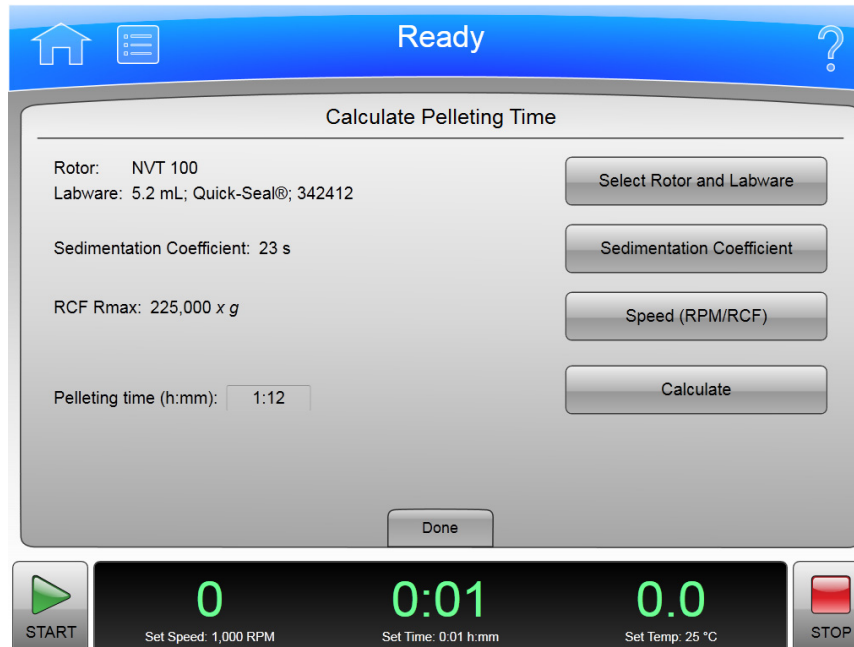
- The **Macromolecule** list displays the macromolecules you can use in the calculation. Select a macromolecule from the list.
- Depending on the selected macromolecule, the button on the right sets molecular mass or molecular length. Select the button, enter the value, and select **OK** to perform the calculation and return to the Determine Sedimentation Coefficient from Molecular Mass page.

NOTE The button shown on the page as **Molecular Mass** changes to **Molecular Length** for the nucleic acid macromolecules (DNA or RNA).

- When you have entered the value, the **Sedimentation Coefficient** field displays the calculated sedimentation coefficient.
- The **Done** button dismisses the page.

Calculate Pelleting Time Page

Figure 8.70 Calculate Pelleting Time Page



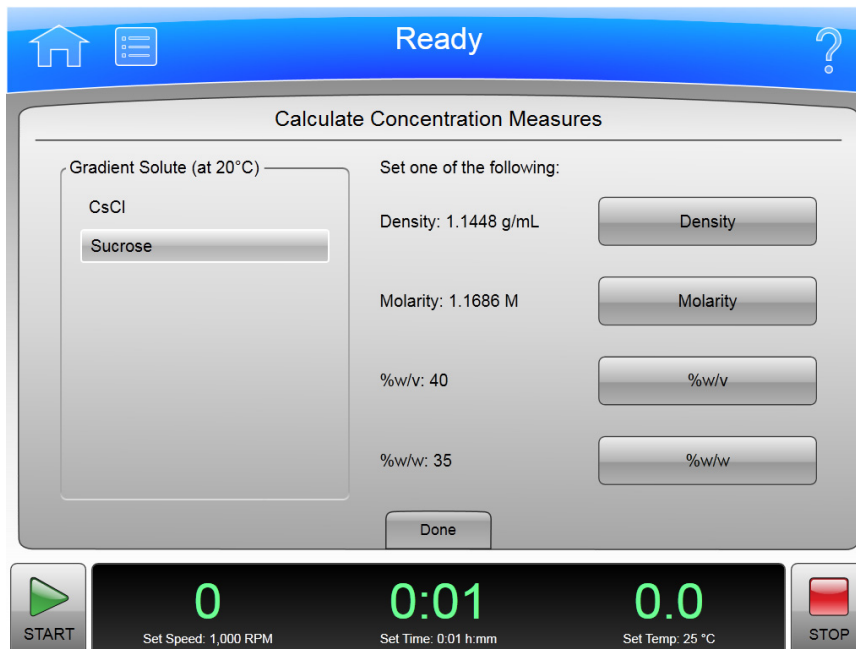
To calculate particle pelleting time, select the **Pelleting Time** button on the [Calculations Page](#) to display the **Calculate Pelleting Time** page. See [Pelleting Time](#) for more information.

In addition to the Header Bar and the Footer Bar, the Calculate Pelleting Time page contains the following elements:

- The **Select Rotor and Labware** button displays the [Select Rotor and Labware Page \(Catalog\)](#). Select the rotor and labware to use for the calculation and select **OK** to return to the Calculate Pelleting Time page.
- The **Sedimentation Coefficient** button displays the **Sedimentation Coefficient** page to enter the sedimentation coefficient. Enter the number and select **OK** to return to the Calculate Pelleting Time page.
- The **Speed (RPM/RCF)** button displays the **Set Speed** page to enter the speed. Enter a speed in either RPM or RCF units, and select **OK** to return to the Calculate Pelleting Time page.
- When you have entered the values, select the **Calculate** button to display the calculated pelleting time.
- The **Done** button dismisses the page.

Calculate Concentration Measures Page

Figure 8.71 Calculate Concentration Measures Page



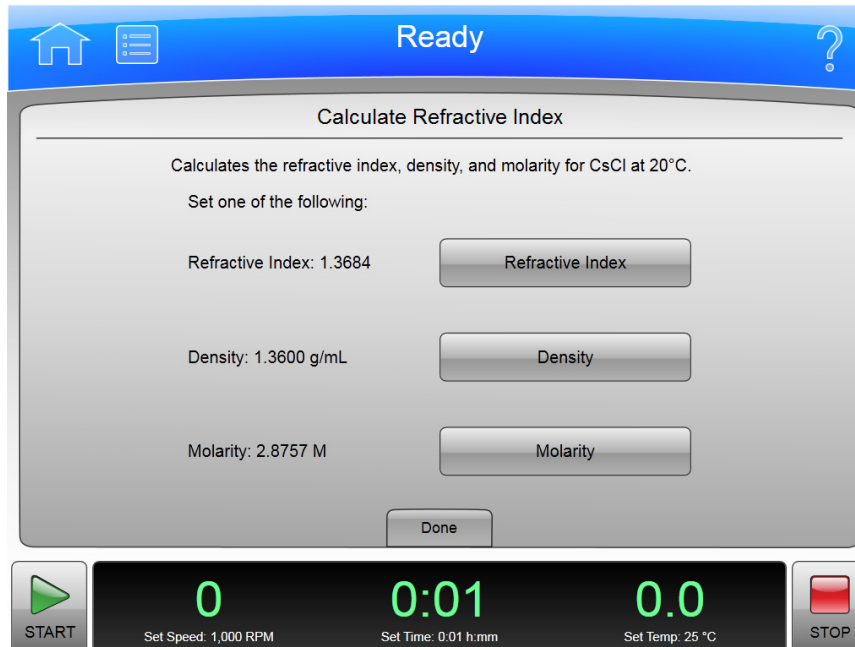
To convert concentration measures between density, molarity, %weight/volume, or % weight/weight, select the **Concentration Measures** button on the [Calculations Page](#) to display the **Calculate Concentration Measures** page. See [Concentration Measures](#) for more information.

In addition to the Header Bar and the Footer Bar, the Calculate Concentration Measures page contains the following elements:

- The **Gradient Solute** list determines the gradient medium. Select a solute from the list.
- The **Density** button is one of the four conversion measurements. Select this button to enter the density and select **OK** to return to the Calculate Concentration Measures page and calculate the conversions to the other three measurements.
- The **Molarity** button is one of the four conversion measurements. Select this button to enter the molarity and select **OK** to return to the Calculate Concentration Measures page and calculate the conversions to the other three measurements.
- The **%w/v** button is one of the four conversion measurements. Select this button to enter the %weight/volume and select **OK** to return to the Calculate Concentration Measures page and calculate the conversions to the other three measurements.
- The **%w/w** button is one of the four conversion measurements. Select this button to enter the %weight/weight and select **OK** to return to the Calculate Concentration Measures page and calculate the conversions to the other three measurements.
- The **Done** button dismisses the page.

Calculate Refractive Index Page

Figure 8.72 Calculate Refractive Index Page



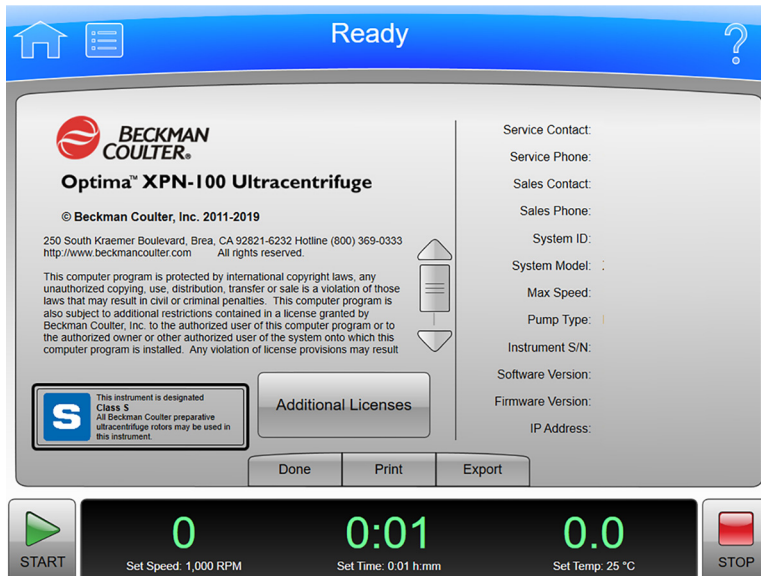
To calculate the refractive index, density, and molarity for CsCl at 20°C, select the **Refractive Index** button on the [Calculations Page](#) to display the **Calculate Refractive Index** page. See [Refractive Index](#) for more information.

In addition to the Header Bar and the Footer Bar, the Calculate Refractive Index page contains the following elements:

- The **Refractive Index** button is one of the three calculation measurements. Select this button to enter the refractive index and select **OK** to return to the Calculate Refractive Index page and calculate the other two measurements.
- The **Density** button is one of the three calculation measurements. Select this button to enter the density and select **OK** to return to the Calculate Refractive Index page and calculate the other two measurements.
- The **Molarity** button is one of the three calculation measurements. Select this button to enter the molarity and select **OK** to return to the Calculate Refractive Index page and calculate the other two measurements.
- The **Done** button dismisses the page.

About Page

Figure 8.73 About Page



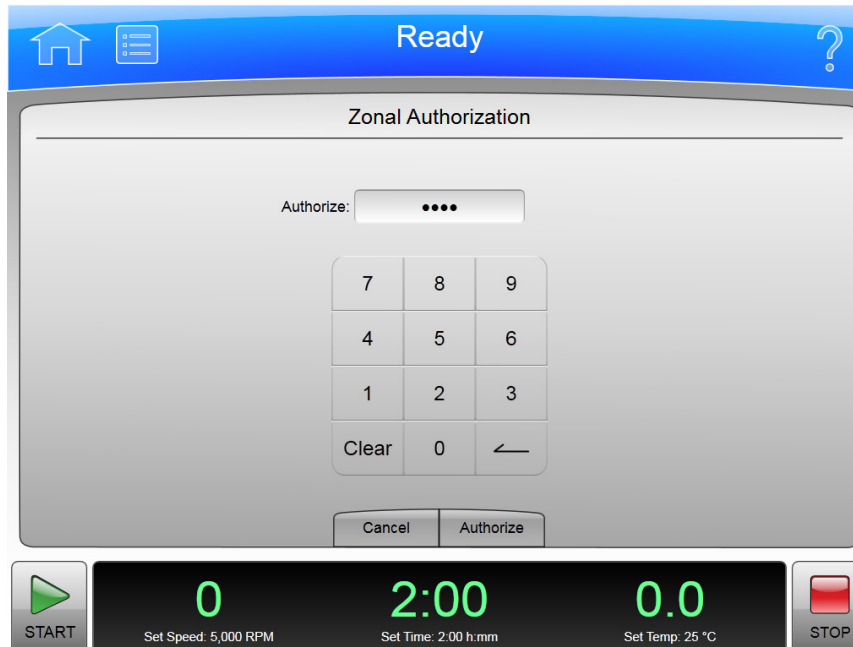
The **About** page (Figure 8.73) appears when you select the **About** button on the [Home Page](#). This page presents system information about your instrument.

In addition to the Header Bar and the Footer Bar, the **About** page contains the following operating elements:

- The **Done** button dismisses the page.
- The **Print** button prints the page.
- The **Export** button displays the [Export Page](#).

Zonal/Continuous Flow Authorization Page

Figure 8.74 Zonal Authorization Page



Select the **Zonal Mode** button on the side menu of the [Home Page](#), or the **Zonal Operation** button on the [Menu Page](#) to display the **Zonal Authorization** page. Enter the authorization code (1793) and select **Authorize** to use Zonal mode for the next run.

Figure 8.75 Zonal Mode Button



Select the **Continuous Flow Operation** button on the [Menu Page](#) to display the **Continuous Flow Authorization** page. Enter the authorization code (1793) and select **Authorize** to use Continuous Flow mode for the next run.

In addition to the Header Bar and the Footer Bar, the **Zonal/Continuous Flow Authorization** page contains the following elements:

- The **Cancel** button dismisses the page without entering Zonal or Continuous Flow mode.
- The **Authorize** button submits the authorization code and, if correct, displays the [Zonal/Continuous Flow Operation Page](#), which replaces the [Home Page](#) while you are using Zonal or Continuous Flow mode.

Zonal/Continuous Flow Operation Page

Figure 8.76 Zonal Operation Page

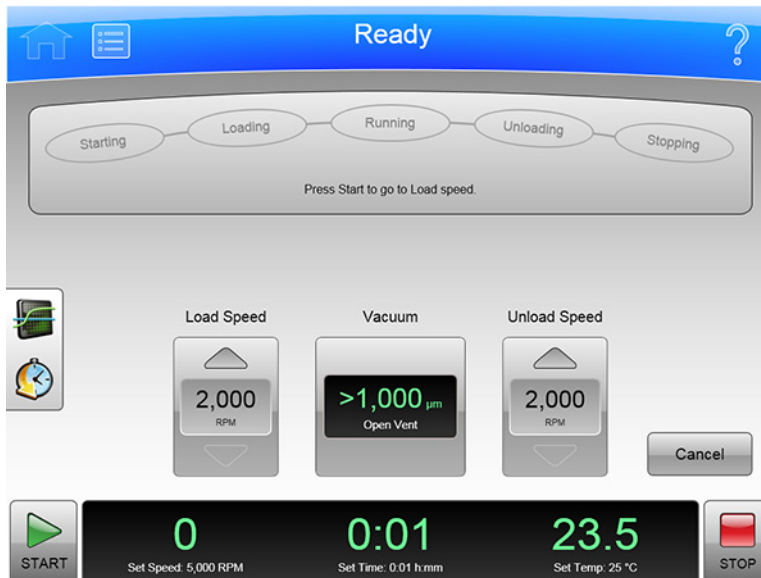
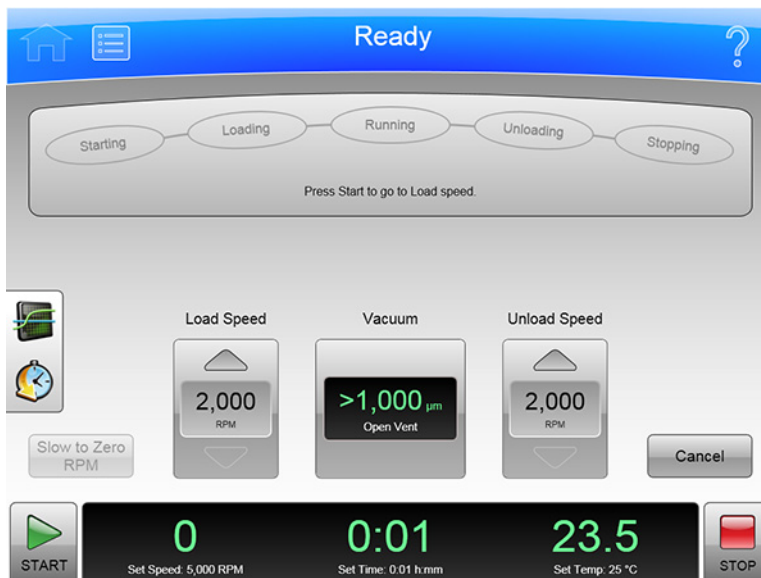


Figure 8.77 Continuous Flow Operation Page



Enter the correct authorization code from the [Zonal Authorization Page](#) to display the **Zonal Operation** page and enter Zonal mode.

Enter the correct authorization code from the [Continuous Flow Authorization Page](#) to display the **Continuous Flow Operation** page and enter Continuous Flow mode.

When you use Zonal or Continuous Flow mode, the **Zonal Operation** page or the **Continuous Flow Operation** page replaces the [Home Page](#) until Zonal or Continuous Flow mode ends.

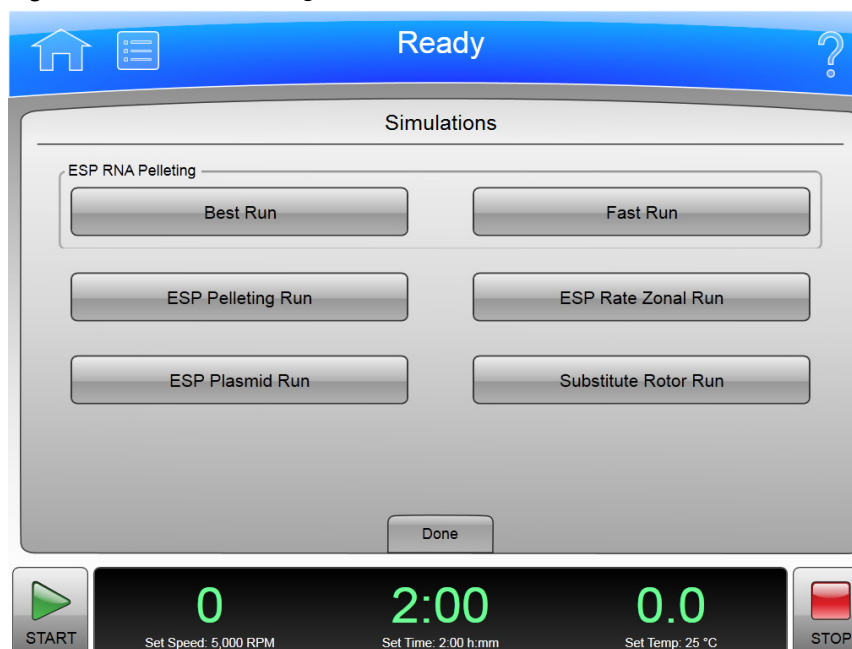
In addition to the Header Bar and the Footer Bar, the **Zonal/Continuous Flow Operation** page contains the following elements:

- The **Status** Display/Buttons show the current step in the Zonal or Continuous Flow run procedure. Once a run has started, the **Loading**, **Running**, and **Unloading** buttons become active and are used to move between process steps.
- In Continuous Flow mode only, the **Slow to Zero RPM** button is for preliminary steps which require bringing the rotor to a stop temporarily during the initial loading adjustments.
- The **Load Speed** Display shows the sample loading speed. Use the arrow buttons above and below to increase or decrease the sample loading speed.
- As a display, the **Vacuum** Display/Button shows the current chamber vacuum and the action that will be performed when you select the button. As a control, it serves two functions:
 - Before a run, select this button to evacuate and precondition the chamber to the set temperature, after you mount a rotor and close the chamber door.
 - After a run, select this button to release the vacuum before opening the chamber door.
- The **Unload Speed** Display shows the sample unloading speed. Use the arrow buttons above and below to increase or decrease the sample unloading speed.
- The **Cancel** button ends Zonal or Continuous Flow mode before loading is complete, and returns to the **Home** page. **Cancel** is available only until you start the run or select **Slow to Zero RPM**. When the run is in progress, use **Stop** to end the run and exit Zonal or Continuous Flow mode.

Use the Footer Bar for setting the run speed, time, and temperature.

Simulations Page

Figure 8.78 Simulations Page



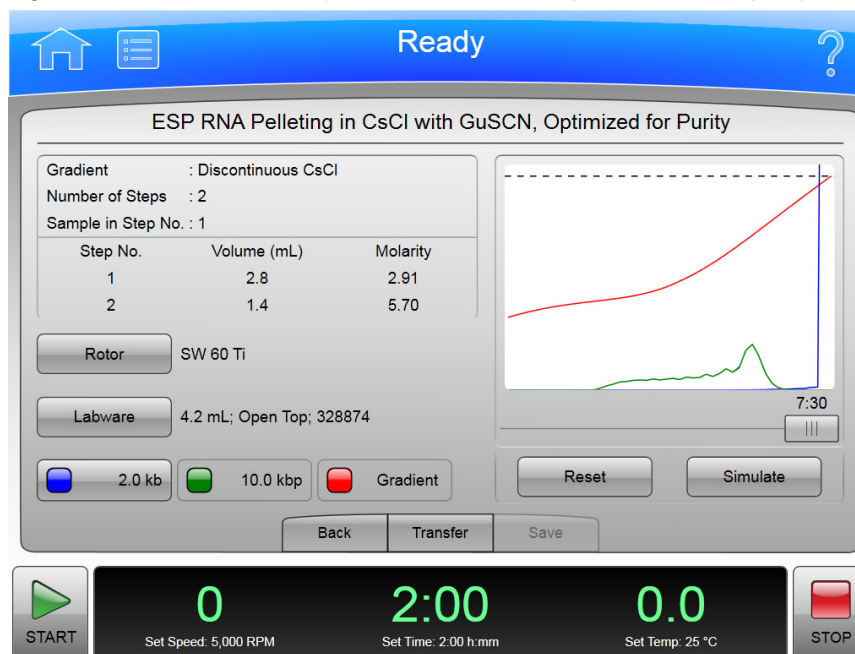
Select the **Simulations** button on the [Menu Page](#) to display the **Simulations** page. Use this page to optimize centrifugation runs through computer simulation. See [Using Simulations](#) for more information.

In addition to the Header Bar and the Footer Bar, the **Simulations** page contains the following elements:

- The **ESP RNA Pelleting** section includes buttons for [Best Run](#) and for [Fast Run](#). Select the appropriate button to display the page for the simulation.
- The **ESP Pelleting Run** button displays the [ESP Pelleting Separation Page](#).
- The **ESP Plasmid Run** button displays the [ESP Optimized Plasmid DNA Separation Page](#).
- The **ESP Rate Zonal Run** button displays the [ESP Rate Zonal Separation Page](#).
- The **Substitute Rotor Run** button displays the [Substitute Rotor Run Page](#).
- The **Done** button dismisses the page.

ESP RNA Pelleting in CsCl with GuSCN, Optimized for Purity Page

Figure 8.79 ESP RNA Pelleting in CsCl with GuSCN, Optimized for Purity Page



To display the **ESP RNA Pelleting in CsCl with GuSCN, Optimized for Purity** page, select the **Best Run** button on the [Simulations Page](#). Use this page to simulate the pelleting of RNA molecules in the range 0.1 to 3.0 kb through a cushion of 5.7 M CsCl at 25°C in a swinging bucket rotor, separating the RNA from chromosomal DNA contaminant. In the simulation, the sample is suspended in 2.91 M CsCl containing 4M GuSCN layered over the CsCl cushion. See [Using Simulations](#) for more information.

In addition to the Header Bar and the Footer Bar, the ESP RNA Pelleting in CsCl with GuSCN, Optimized for Purity page contains the following elements:

- The **Rotor** button displays the [Select Rotor and Labware Page \(Catalog/Library\)](#). Select the rotor and labware to use for the simulation and select **OK** to return to this page.
- The **Labware** button also displays the [Select Rotor and Labware Page \(Catalog/Library\)](#).
- The Supercoiled DNA button, with the -kb designation, determines molecular length. Select the button to enter the molecular length and select **OK** to return to this page.
- When you have entered the fields, select the **Simulate** button to display the simulated run. The simulation is graphically displayed.
 - The blue curve represents the relative concentration of the RNA.
 - The green curve represents the relative concentration of the DNA contaminant.
 - The red curve represents the density of the CsCl gradient.
 - The dotted line at the top of the graph represents the concentration at which CsCl precipitates.

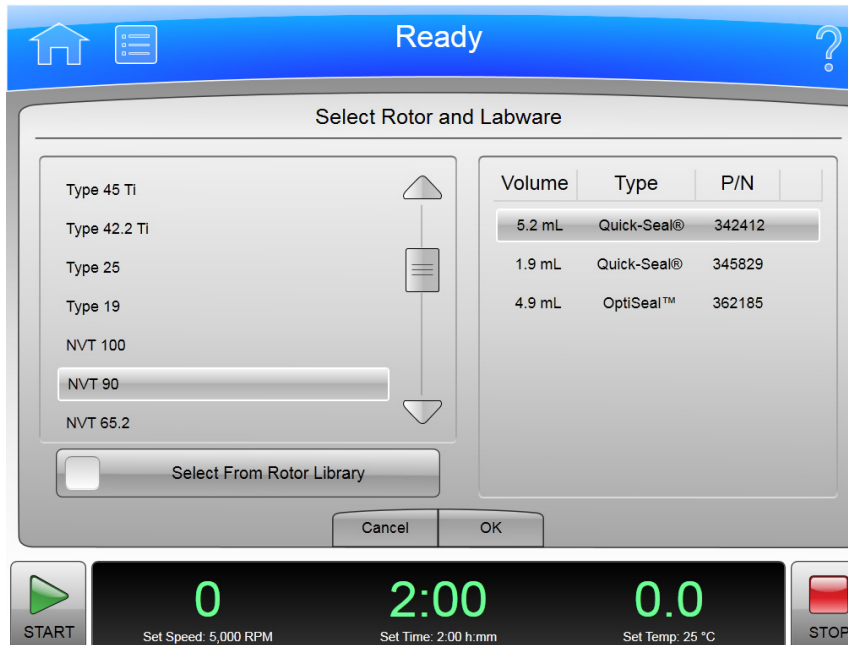
The maximum time required for the separation is shown above the slide bar. Use the slide bar to display separations at shorter run times. The y-axis represents both the relative concentration of the particles and the density of the CsCl gradient during centrifugation. The x-axis indicates the position of the particles along the length of the tube with the bottom of the tube at the right.

- The **Reset** button clears the **Rotor**, **Labware** and Molecular Length fields.
- The **Back** button returns to the [Simulations Page](#).
- The **Transfer** button transfers the current simulated run settings to the instrument settings for a live run.
- The **Save** button saves the simulated run settings as a named run program, which can be run at a later time.

NOTE Saving or transferring the simulation settings does not save the simulation inputs, only the current simulated run settings (including the adjustments for a shorter elapsed time, if applicable).

Select Rotor and Labware Page (Catalog/Library)

Figure 8.80 Select Rotor and Labware Page (Catalog/Library)



To select a type of rotor for a simulation, select the **Select Rotor** button on the simulation page to display the **Select Rotor and Labware** page (Catalog/Library). This page displays the complete list of rotors that can be used with the XPN.

In addition to the Header Bar and the Footer Bar, the **Select Rotor and Labware** page (Catalog/Library) contains the following elements:

- The Rotor Catalog list shows the rotors that can be used with the instrument. Select a rotor from this list to indicate the kind of rotor to use for the simulation.
- To select a rotor from the instrument's Rotor Library instead of the Catalog list, enable the **Select From Rotor Library** button. The Rotor Catalog list changes to the Rotor Library list, showing the available rotors for the instrument. To return to the Rotor Catalog list, disable the **Select From Rotor Library** button.
- When you select a rotor, the Labware list displays compatible labware. Select a type of labware from the list.

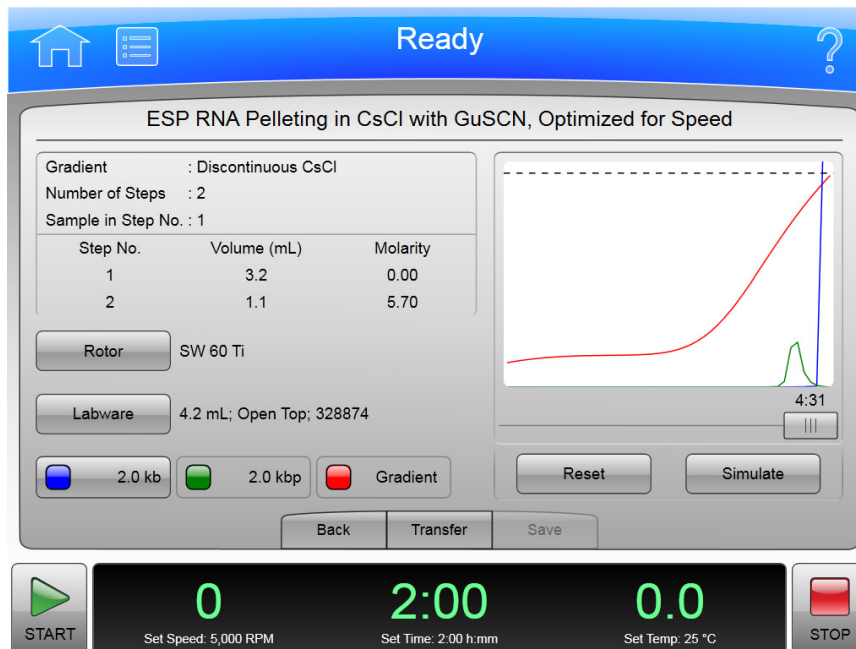
NOTE Under the "Type" field in the Labware list, some of the labware will have a -CF or -S suffix. The -CF suffix indicates the labware is Certified Free of various contaminants. The -S suffix indicates the labware is Sterilized in addition to being Certified Free of contaminants. Search the labware part number on www.beckman.com for more information.

- The **Cancel** button cancels your selection and dismisses the page.
- The **OK** button saves the selection and dismisses the page.

For details about each rotor or type of labware, use the [Rotor Catalog Page](#).

ESP RNA Pelleting in CsCl with GuSCN, Optimized for Speed Page

Figure 8.81 ESP RNA Pelleting in CsCl with GuSCN, Optimized for Speed Page



To display the **ESP RNA Pelleting in CsCl with GuSCN, Optimized for Speed** page, select the **Fast Run** button on the [Simulations Page](#). Use this page to simulate the pelleting of RNA molecules in the range 0.1 to 3.0 kb through a cushion of 5.7 M CsCl at 25°C in a swinging bucket rotor, separating the RNA from chromosomal DNA contaminant. See [Using Simulations](#) for more information.

In addition to the Header Bar and the Footer Bar, the ESP RNA Pelleting in CsCl with GuSCN, Optimized for Speed page contains the following elements:

- The **Rotor** button displays the [Select Rotor and Labware Page \(Catalog/Library\)](#). Select the rotor and labware to use for the simulation and select **OK** to return to this page.
- The **Labware** button also displays the [Select Rotor and Labware Page \(Catalog/Library\)](#).
- The Supercoiled DNA button, with the -kb designation, determines molecular length. Select the button to enter the molecular length and select **OK** to return to this page.
- When you have entered the fields, select the **Simulate** button to display the simulated run. The simulation is graphically displayed.
 - The blue curve represents the relative concentration of the RNA.
 - The green curve represents the relative concentration of the DNA contaminant.
 - The red curve represents the density of the CsCl gradient.
 - The dotted line at the top of the graph represents the concentration at which CsCl precipitates.

The maximum time required for the separation is shown above the slide bar. Use the slide bar to display separations at shorter run times. The y-axis represents both the relative concentration of the particles and the density of the CsCl gradient during centrifugation. The

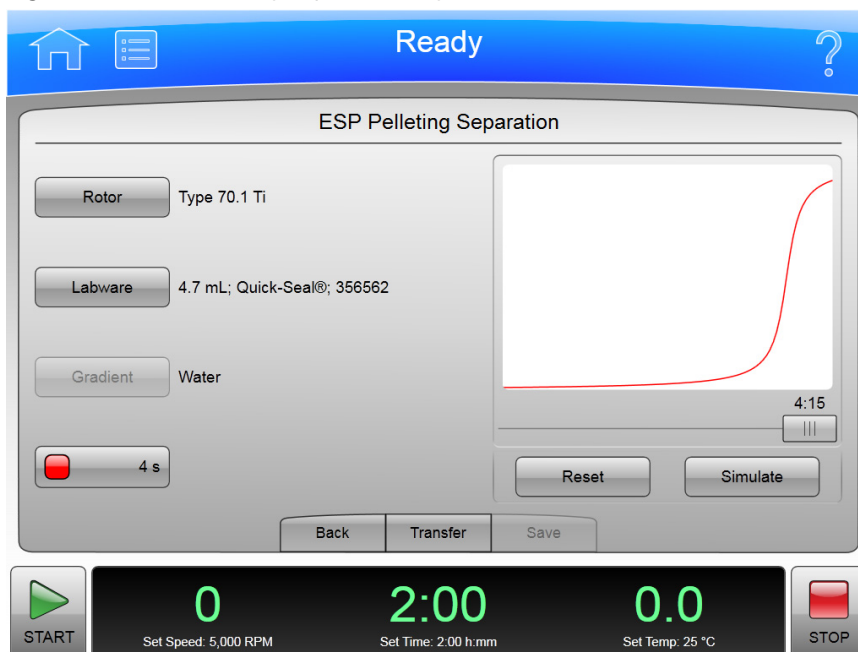
x-axis indicates the position of the particles along the length of the tube with the bottom of the tube at the right.

- The **Reset** button clears the **Rotor**, **Labware** and Molecular Length fields.
- The **Back** button returns to the [Simulations Page](#).
- The **Transfer** button transfers the current simulated run settings to the instrument settings for a live run.
- The **Save** button saves the simulated run settings as a named run program, which can be run at a later time.

NOTE Saving or transferring the simulated run settings does not save the simulation inputs, only the current simulated run settings (including the adjustments for a shorter elapsed time, if applicable).

ESP Pelleting Separation Page

Figure 8.82 ESP Pelleting Separation Page



To display the **ESP Pelleting Separation** page, select the **ESP Pelleting Run** button on the [Simulations Page](#). Use this page to simulate a separation of a uniform mixture of sample solution into two fractions, a pellet containing the sedimented material and a supernatant solution of the unsedimented material. Any particular component in the mixture may end up in the supernatant or in the pellet, or distributed in both fractions (depending on its size and/or the conditions of centrifugation). See [ESP Pelleting Run](#) for more information.

In addition to the Header Bar and the Footer Bar, the ESP Pelleting Separation page contains the following elements:

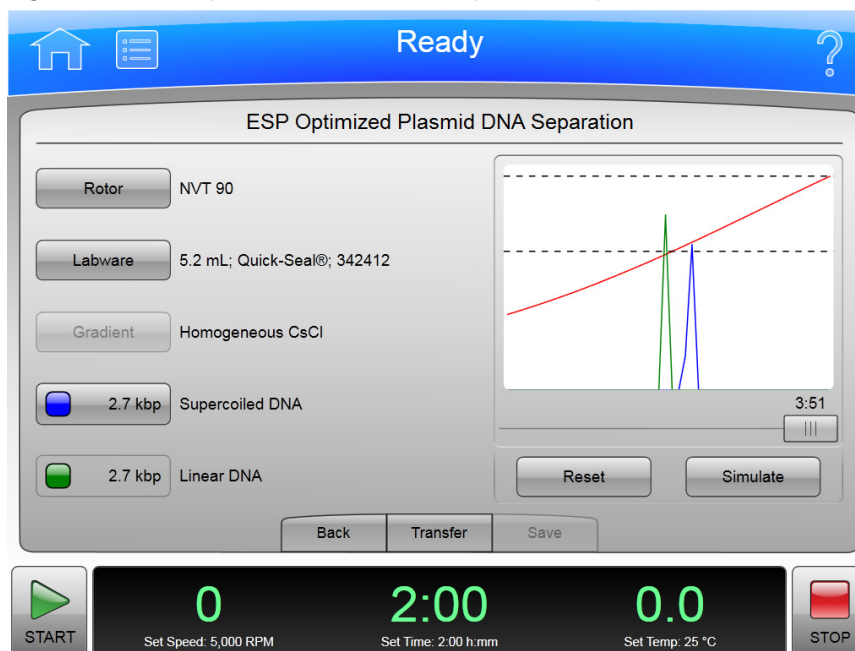
- The **Rotor** button displays the [Select Rotor and Labware Page \(Catalog/Library\)](#). Select the rotor and labware to use for the simulation and select **OK** to return to this page.

- The **Labware** button also displays the [Select Rotor and Labware Page \(Catalog/Library\)](#).
- The **Sedimentation Coefficient** button, with the -s designation, determines sedimentation coefficient. Select the button to enter the sedimentation coefficient and select **OK** to return to this page.
- When you have entered the fields, select the **Simulate** button to display the simulated run in the graph above. The x-axis is the relative position (volume) of gradient in the tube. The y-axis is the relative concentration (density) of the materials. You can move the slider below the graph to see the effect of a shorter run time.
- The **Reset** button clears the **Rotor**, **Labware** and **Sedimentation Coefficient** fields.
- The **Back** button returns to the [Simulations Page](#).
- The **Transfer** button transfers the current simulated run settings to the instrument settings for a live run.
- The **Save** button saves the simulated run settings as a named run program, which can be run at a later time.

NOTE Saving or transferring the simulation settings does not save the simulation inputs, only the current simulated run settings (including the adjustments for a shorter elapsed time, if applicable).

ESP Optimized Plasmid DNA Separation Page

Figure 8.83 ESP Optimized Plasmid DNA Separation Page



To display the **ESP Optimized Plasmid DNA Separation** pages, select the **ESP Plasmid Run** button on the [Simulations Page](#). Use this page to simulate an optimized plasmid DNA separation in homogeneous 1.55 g/mL CsCl-EtBr at 25°C. The simulation predicts the time at which the required separation will occur. The simulation controls the (simulated) rotor speed to ensure that the CsCl

does not reach a density at the bottom of the tube that could cause precipitation. See [ESP Plasmid Run](#) for more information.

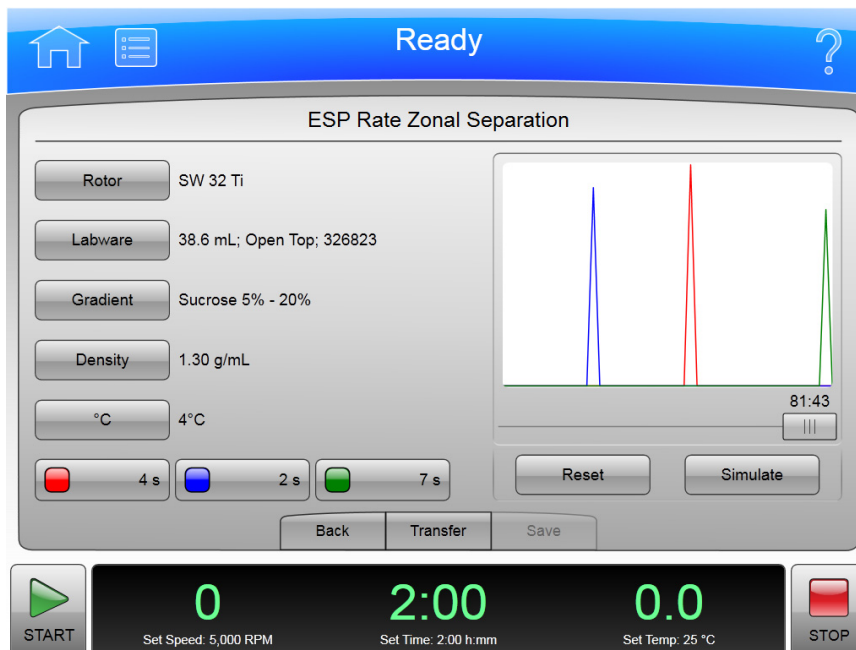
In addition to the Header Bar and the Footer Bar, the **ESP Optimized Plasmid DNA Separation** page contains the following elements:

- The **Rotor** button displays the [Select Rotor and Labware Page \(Catalog/Library\)](#). Select the rotor and labware to use for the simulation and select **OK** to return to this page.
- The **Labware** button also displays the [Select Rotor and Labware Page \(Catalog/Library\)](#).
- The Supercoiled DNA button, with the -kbp designation, determines molecular length. Select the button to enter the molecular length and select **OK** to return to this page.
- When you have entered the fields, select the **Simulate** button to display the simulated run in the graph above. The x-axis is the relative position (volume) of gradient in the tube. The y-axis is the relative concentration (density) of the materials. You can move the slider below the graph to see the effect of a shorter run time.
- The **Reset** button clears all the fields.
- The **Back** button returns to the [Simulations Page](#).
- The **Transfer** button transfers the current simulated run settings to the instrument settings for a live run.
- The **Save** button saves the simulated run settings as a named run program, which can be run at a later time.

NOTE Saving or transferring the simulated run settings does not save the simulated run inputs, only the current simulated run settings (including the adjustments for a shorter elapsed time, if applicable).

ESP Rate Zonal Separation Page

Figure 8.84 ESP Rate Zonal Separation Page



To display the **ESP Rate Zonal Separation** page, select the **ESP Rate Zonal Run** button on the [Simulations Page](#). Use this page to simulate the separation of sample components as a function of time and radial position. Particle separation achieved with rate zonal separation is a function of the particles' sedimentation coefficient and density, and the viscosity of the gradient material. Under centrifugal force, particles migrate as zones. Rate zonal separation is time dependent. See [ESP Rate Zonal Run](#) for more information.

In addition to the Header Bar and the Footer Bar, the **ESP Rate Zonal Separation** page contains the following elements:

- The **Rotor** button displays the [Select Rotor and Labware Page \(Catalog/Library\)](#). Select the rotor and labware to use for the simulation and select **OK** to return to this page.
- The **Labware** button also displays the [Select Rotor and Labware Page \(Catalog/Library\)](#).
- The **Gradient** button displays the **Gradient** page. Select a gradient or enter a custom range and select **OK** to return to this page.
- The **Density** button sets the density for the simulation. Enter the density and select **OK** to return to the simulation page.
- The **°C** button sets the temperature for the simulation. Enter the temperature and select **OK** to return to the simulation page.
- Enter the sedimentation coefficients for up to three particles of interest by selecting the Sedimentation Coefficient buttons, with the -s designations, at the bottom of the page.
- When you have entered the fields, select the **Simulate** button to display the simulated run in the graph above. The x-axis is the relative position (volume) of gradient in the tube. The y-axis is the relative concentration (density) of the materials. You can move the slider below the graph to see the effect of a shorter run time.
- The **Reset** button clears all the fields.
- The **Back** button returns to the [Simulations Page](#).
- The **Transfer** button transfers the current simulated run settings to the instrument settings for a live run.
- The **Save** button saves the simulated run settings as a named run program, which can be run at a later time.

NOTE Saving or transferring the simulated run settings does not save the simulation inputs, only the current simulated run settings (including the adjustments for a shorter elapsed time, if applicable).

Substitute Rotor Run Page

Figure 8.85 Substitute Rotor Run Page



To convert a set of run settings from one type of rotor and labware to another, select the **Substitute Rotor Run** button on the [Simulations Page](#) to display the **Substitute Rotor Run** page. See [Substitute Rotor Run](#) for more information.

In addition to the Header Bar and the Footer Bar, the Substitute Rotor Run page contains the following elements:

- The Source Rotor section contains the settings buttons for the original run settings.
 - Select the **Rotor/Labware** button to display the [Select Rotor and Labware Page \(Catalog/Library\)](#) and select the source rotor and labware of the original run. Select **OK** to return to the Substitute Rotor Run page.
 - To define a source rotor that is not in the catalog, select **Rmin/Rmax** to enter a custom minimum and maximum test tube radius in millimeters for the source rotor. The Rotor/Labware becomes User Defined.
 - Select **Speed/Time** to enter the speed and time of the original run. Select **OK** to return to the Substitute Rotor Run page.
- The Target Rotor section contains the settings buttons for your substitute settings.
 - Select the **Rotor/Labware** button to display the [Select Rotor and Labware Page \(Catalog/Library\)](#) and select the target rotor and labware to use for the simulation. Select **OK** to return to the Substitute Rotor Run page.
 - Select **Temperature** to enter the temperature for the simulation. Select **OK** to return to the Substitute Rotor Run page.
 - Select **Speed** to enter the speed for the simulation. Select **OK** to return to the Substitute Rotor Run page.

- The **Back** button returns to the [Simulations Page](#).
- The **Transfer** button transfers the current simulated run settings to the instrument settings for a live run.
- The **Save** button saves the simulated run settings as a named run program, which can be run at a later time.

NOTE Saving or transferring the simulated run settings does not save the simulation inputs, only the current simulated run settings.

Maintenance and Troubleshooting

This chapter contains care and maintenance procedures to be performed regularly.

Field Service

For any maintenance not covered in this manual, contact Beckman Coulter Field Service for assistance. USA customers can call 1-800-742-2345. For international contacts, see the website at www.beckman.com or use the contact numbers on the inside front cover of this book.

NOTE It is your responsibility to decontaminate the instrument, as well as any rotors and accessories, before requesting service by Beckman Coulter Field Service.

Rotors and Labware

You also need to maintain rotors and labware. You can find the approved rotors and labware on the **Reference** Page as described in the previous chapter. Refer to the applicable rotor and labware documents for detailed instructions on their care.

Cleaning

The methods and materials used in the following procedures have been tested by Beckman Coulter and will not damage the instrument if used as instructed.



Before using any other materials or methods, check with Beckman Coulter to verify that they will not damage the instrument.

Instrument Surfaces

Clean instrument surfaces using a cloth dampened with a mild detergent solution, such as Beckman Solution 555.



Be careful not to spill liquid on the instrument where electrical or mechanical components could get damaged.

Rotor Chamber

The rotor chamber is coated with epoxy resin paint. To clean the chamber, wipe it with a cloth dampened with a mild detergent, such as Beckman Solution 555.

Chamber Door O-ring

The chamber door O-ring is Buna N rubber. Clean it with a tissue or soft cloth every 3 or 4 months.

If the O-ring becomes worn or damaged, replace it. Lightly coat the new O-ring with silicone vacuum grease (335148) to ensure an optimum vacuum seal.

NOTE Instrument O-rings have **not** been designed as bioseals for aerosol containment.

Decontamination

If the instrument and/or accessories are contaminated with radioactive or pathogenic solutions, follow appropriate decontamination procedures as determined by your laboratory safety officer. Refer to Chemical Resistances (publication IN-175), or contact Beckman Coulter Field Service to ensure that the decontamination method does not damage any part of the instrument (or accessories).

Sterilization and Disinfection



While Beckman Coulter has tested these methods and found that they do not damage the instrument, no guarantee of sterility or disinfection is expressed or implied. When sterilization or disinfection is a concern, consult your laboratory safety officer regarding proper methods.

The top working surface is finished with urethane paint. The sides are finished with general purpose paint. You can use Ethanol (70%) on both these surfaces.



Ethanol is a volatile liquid that cannot be used on or near an operating instrument due to fire hazard.

Diagnostics/User Messages

When a condition arises that requires operator attention, the header bar turns yellow or red. A page displays the diagnostic message. User messages communicate information about the ultracentrifuge or alert you to an abnormal condition. For a list of the possible malfunctions and their corrective actions, see [APPENDIX C, Diagnostics](#).

Retrieving Your Sample in Case of Power Failure

The instrument responds to a power failure during operations in two different ways:

- Power failed during a run and the rotor is still spinning when power is restored.
- Power failed during a run and the rotor has stopped when power is restored.

During a Run

If a power failure occurs during a run, the rotor begins to decelerate with the brake off. The corrected run time is determined when power is restored and, if the set run time has not elapsed, the run will resume as described. Note that a rotor decelerating without the brake may take hours to come to a complete stop.

Rotor Spinning at Restoration

If the rotor is still spinning when power is restored, the instrument takes the following steps:

- Return to the set speed.
- Resume incrementing the run timer.
- Set a diagnostic message to alert you that a power failure occurred during the run.

Rotor Stopped at Restoration

If the rotor has stopped spinning when power is restored, the instrument cancels the run and sends a diagnostic message to alert you to that the run was cancelled due to a power failure.

Getting Access to the Sample

If a power failure lasts for several hours, you may have to remove the sample from the rotor while there is no power to the instrument. The procedure requires removing the front panel, which should be done only by qualified service personnel.



Any maintenance procedure requiring removal of a panel exposes the operator to the possibility of electrical shock and/or physical injury. If any such procedure becomes necessary, turn the power switch OFF, and then disconnect the instrument from the main power source by removing its power plug from the receptacle. Refer the maintenance to qualified service personnel.

To get access to the rotor, follow these steps:

- Disconnect the power by removing its power plug from the receptacle.
- Remove the front panel.
- Vent the chamber to release the vacuum.
- Release the door lock.
- Open the door.



The following procedure should be performed only when absolutely necessary and only by qualified service personnel.

Check Power

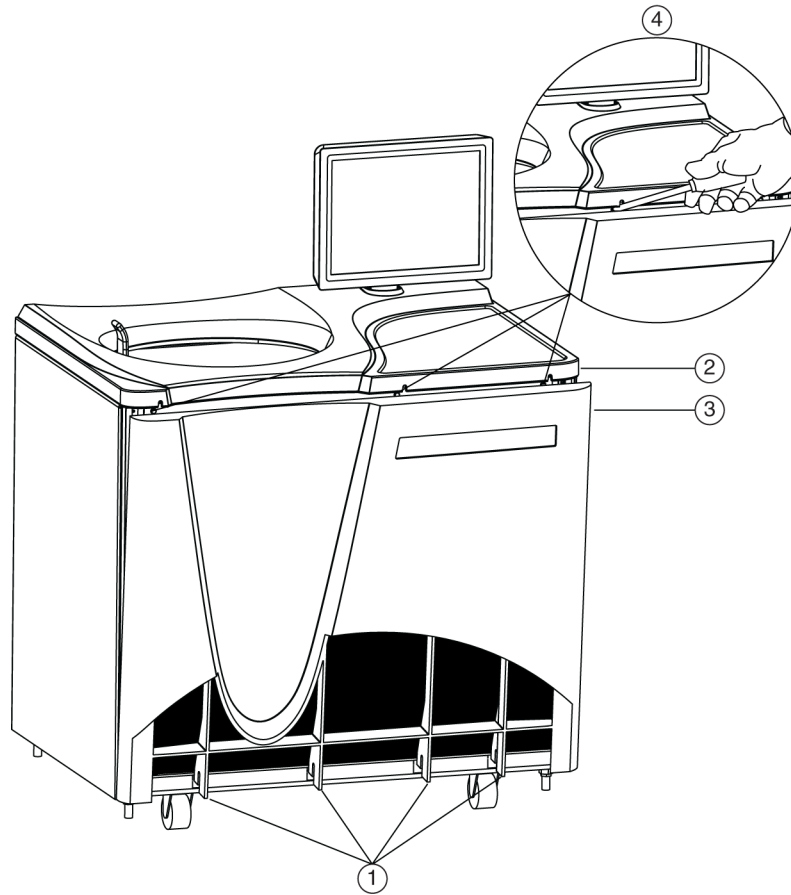
Check that the power switch is in the OFF position and the instrument is disconnected from the power (i.e., the power plug is removed from its receptacle).

Remove the Front Panel

To remove the front panel:

- 1 Locate the three front panel latch screws and use a small flat-head screwdriver to turn each latch screw counter-clockwise until each one is loose. Refer to [Figure 9.1](#).

Figure 9.1 Panel screws and Tabs



- | | |
|---------------|-----------------|
| 1. Panel Tabs | 3. Front Panel |
| 2. Top Panel | 4. Latch Screws |

2 When all three latch screws are loose, use your hand to lift the top panel until it pops loose.

3 Lift the front panel until it is free and tilt the top edge towards you.

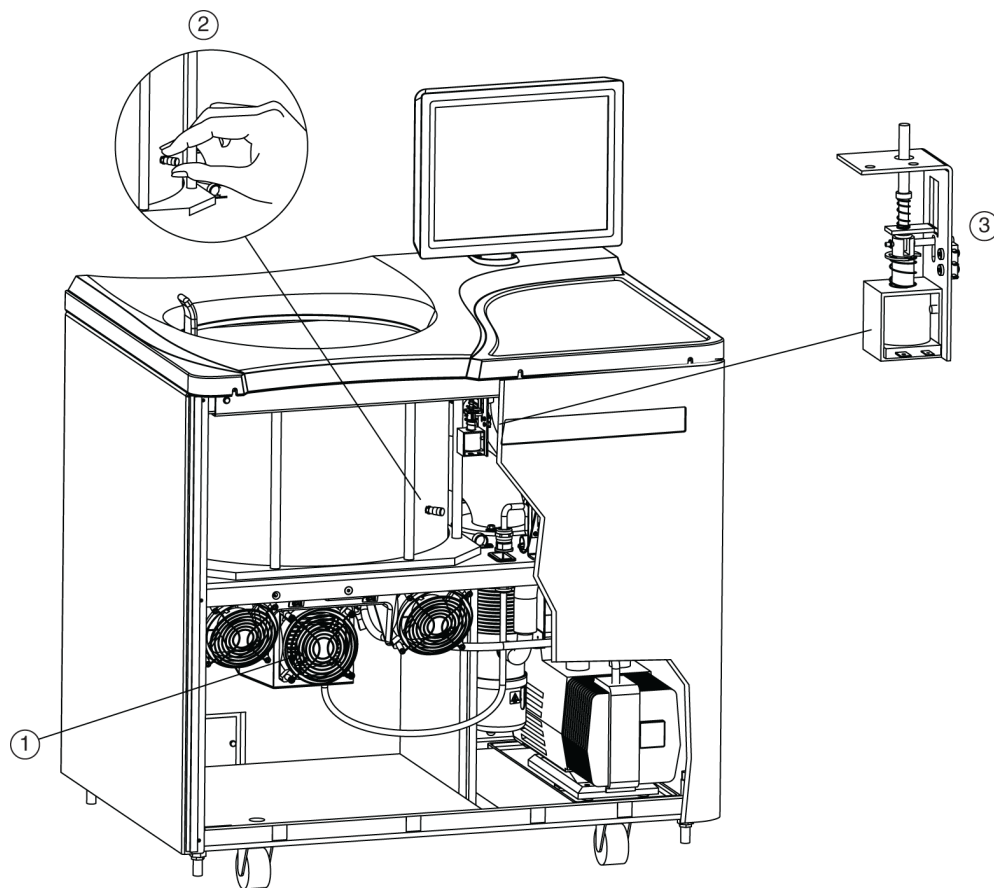
4 Lift the front panel off the tabs that secure it at the bottom and put it in a safe place.

WARNING

When working on the inside of the instrument, be careful not to touch any wires or circuitry.

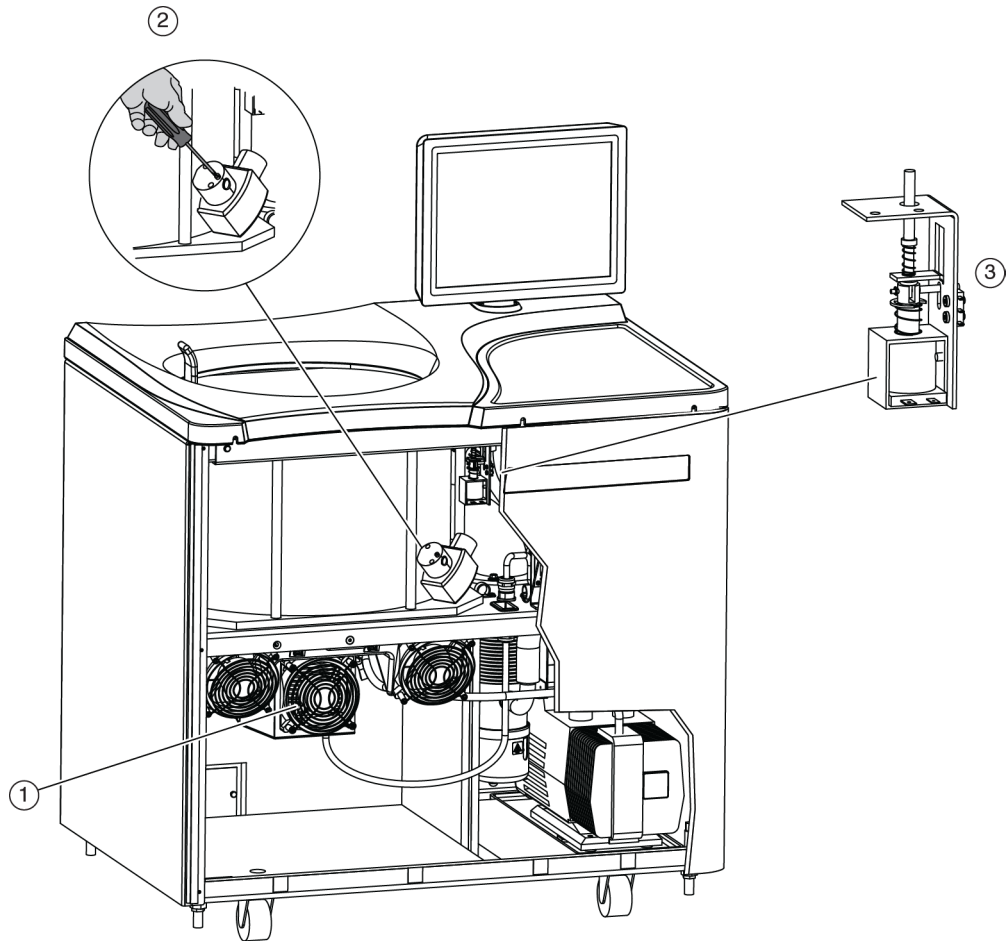
- 5 Determine the instrument's vacuum configuration. There are two possible configurations:
- **Configuration "A"** will vent the vacuum through a vent port cap (refer to [Figure 9.2](#)).
 - **Configuration "B"** will vent the vacuum through a solenoid release screw (refer to [Figure 9.3](#)).

Figure 9.2 Internal Parts — Configuration "A" vents through the port cap



1. Fan Housing
2. Vacuum Vent Port Cap
3. Door Interlock Assembly

Figure 9.3 Internal Parts — Configuration “B” vents through the vacuum solenoid release screw



1. Fan Housing
2. Vacuum solenoid release screw
3. Door Interlock Assembly

Also refer to *To Vent the Chamber- Configuration “A” with vent port cap*., and *To Vent the Chamber- Configuration “B” with solenoid release screw*..

- 6 Listen carefully for any sounds coming from the drive and touch the fan housing to feel for vibrations. If you detect any sounds or vibrations, do not go further. The rotor is still spinning and you must wait for it to come to a stop.

Vent the Chamber

Although you checked for noise and vibration, there is still a possibility that the rotor is still spinning. If it is still spinning, you can hear a whining noise when you begin to vent the chamber. If you hear the whining noise when you begin to vent the chamber, you must close the port immediately and wait for the rotor to come to a stop. The following steps describe the procedure you must follow for each configuration:

To Vent the Chamber- Configuration “A” with vent port cap:

- 1** Locate the vacuum vent port cap on the side of the rotor chamber.

- 2** Turn the cap very slowly counter-clockwise until you can hear the hiss of air entering the chamber.

- 3** If you hear a whining noise, immediately turn the cap clockwise to close it and wait until the rotor has had time to come to a stop (at least an hour) before attempting to vent the chamber again.

- 4** When air flows into the chamber without a whining noise, remove the cap completely.

To Vent the Chamber- Configuration “B” with solenoid release screw:

- 1** Locate the vacuum solenoid release screw on the side of the rotor chamber.

- 2** Using a screwdriver, turn the screw very slowly clockwise until you can hear the hiss of air entering the chamber.

- 3** If you hear a whining noise, immediately turn the screw counter-clockwise to close it and wait until the rotor has had time to come to a stop (at least an hour) before attempting to vent the chamber again.

- 4** When air flows into the chamber without a whining noise, continue to turn the screw clockwise.

Release the Door Lock

Locate the door interlock assembly. Pull down on the interlock pin until it locks in the downward position.

Open the Door

Open the chamber door carefully. If the rotor is still spinning, even at a slow speed, close the door and wait.

 **WARNING**

NEVER attempt to slow or stop the rotor by hand.

With the door open and the rotor stopped, you can retrieve your sample.

 **WARNING**

Do not attempt to run the instrument before restoring it to a safe operating condition as described in the following section.

Restoring the Instrument to Operating Condition

After retrieving your sample, restore the instrument to operating condition as follows:

- 1 Close the chamber door.
- 2 Close the vent:
 - **For Configuration “A” with vent port cap:** Replace and tighten the vacuum vent port cap. It should be snug, but do not overtighten it.
 - **For Configuration “B” with solenoid release screw:** Turn the screw counter-clockwise, but do not overtighten it.
- 3 Place the front panel in the tilted position with the top edge toward you, the sides aligned with the sides of the instrument, and the tabs at the bottom edge inserted into the lip at the base of the instrument.
- 4 Lift the front edge of the top panel a few inches and insert the upper edge of the front panel under it. Push back gently to engage the tabs, then push down.
- 5 For each of the three latch screws, use the small flat-head screwdriver to turn it clockwise until snug.
- 6 After the panels are all secure, reconnect the instrument to the power supply.

The instrument is again ready for use when power is restored.

Storage and Transportation

To ensure that the instrument does not get damaged, contact Beckman Coulter Field Service for specific instructions and/or assistance in preparing the equipment for transport or long-term storage.

Supply List

Contact Beckman Coulter Sales for assistance ordering parts and supplies. Customers in the United States call 1-800-742-2345. For international contacts, see the website at www.beckman.com or use the contact numbers on the inside front cover of this book. A partial list of supplies is given below for your convenience. See the Beckman Coulter *Ultracentrifuge Rotors, Tubes & Accessories* catalog (BR-8101, available at www.beckman.com) for detailed information on ordering rotors, tubes, and accessories.

Replacement Parts

| Description | Part Number |
|----------------|-------------|
| Chamber O-ring | 801778 |
| Rotor Pad | B42711 |

Supplies

| Description | Part Number |
|--|-------------|
| Silicone vacuum grease (2 oz) | 335148 |
| Beckman Solution 555 (1 qt) | 339555 |
| Logbook for preparative ultracentrifuges | 330049 |
| Master rotor logbook | 339587 |

NOTE For MSDS information, go to the Beckman Coulter website at www.beckman.com.

Preinstallation Requirements

Overview

NOTE Do not attempt to install or turn on the power to the Optima XPN. Its purchase price includes installation by Beckman Coulter personnel. Installation by anyone other than authorized Beckman Coulter personnel invalidates the instrument warranty.

Preinstallation requirements have been sent prior to shipment of the instrument. Copies are also attached to the outside of the shipping container. The following information is provided in case the instrument must be relocated. Contact Beckman Coulter Field Service to adjust and level the instrument if it must be moved. The pads on each leveling leg are designed to prevent possible rotation of the instrument in the case of a rotor mishap.

Space Requirements

Space requirements include specifications for safety, ventilation, and temperature.

Safety

IMPORTANT This unit or system is provided with fixed trip limits and shall not be aggregated above 30kW on a single point of common connection.

IMPORTANT To reduce the risk of fire, connect only to a circuit provided with 30 amperes maximum branch circuit overcurrent protection in accordance with the National Electrical Code, ANSI/ NFPA 70.

IMPORTANT Additionally:

- Equipment shall be installed on a dedicated branch circuit.
- The branch circuit protection shall be one that is suitable to be back-fed.
- Circuit breakers that are marked with a “line” and “load” have not been evaluated to be back-fed.

Locate the ultracentrifuge in a clean, safe, uncluttered environment free of volatile vapors that could be ignited by the operation of the centrifuge.



Do not place the ultracentrifuge near areas containing flammable reagents or combustible fluids. Vapors from these materials could enter the ultracentrifuge air system and be ignited by the motor.

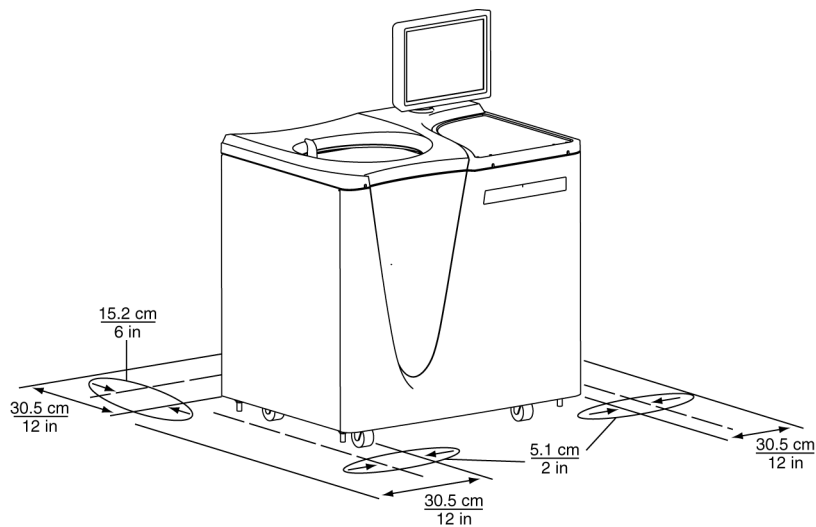
Although the possibility of a rotor failure is remote, your planning should include a safety space around the instrument of 12 inches (30.5 cm.) to allow for the movement of the instrument in the

event that a rotor failure occurs at high rotational speed. If you decide to install the instrument in an area where furniture, equipment, or a wall is within this safety space, you run the risk of damage to anything within this space in the event of a rotor failure.

⚠ WARNING

Maintain a 30.5-cm (1-ft.) clearance envelope around the ultracentrifuge while it is running. No persons or any hazardous materials should be within this clearance boundary while the ultracentrifuge is operating except to change operating controls, if required.

Figure A.1 Safety and ventilation space



Ventilation

If you choose to install the instrument with less than the 12 in./30.5 cm. safety clearance, you must at least provide a required ventilation and service access clearance of 6 in. (15.2 cm.) behind the instrument and 2 in. (5.1 cm.) on each side. In addition, the ultracentrifuge must have adequate air ventilation to ensure compliance to local requirements for vapors produced during operation.

Temperature

The instrument operates within specifications in a laboratory with ambient temperatures ranging from 10 to 35°C.

Electrical Requirements

Instrument Rating: 200 to 240 VAC, 50/60 Hz, 20 A

Power Line Range:
(Input Ratings) 180 to 264 VAC, 60 or 50 Hz (single-phase), 30 A

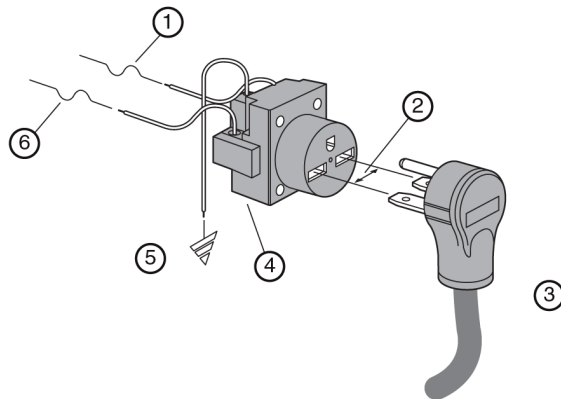
Power Line Range:
(Output Ratings) 200 to 240 VAC, 50/60Hz, 8.5A

IMPORTANT AC output is not bonded to earth ground.

To reduce risk of electrical shock, this equipment uses a three-wire electrical cord (3.05 m; 10 ft.) and plug (see [Figure A.2](#)) to connect the equipment to earth ground. In regions where the instrument is supplied with an unterminated cord, a plug that meets local electrical and safety requirements must be supplied. (Contact your local Beckman Coulter office for specific information regarding these requirements.) See [Table A.1](#) for the required wire connections. Make sure that the matching wall outlet is located near the centrifuge and is easily accessible, properly wired and earth-grounded.

NOTE The power plug serves as the Disconnecting Device and must remain easily accessible.

Figure A.2 Electrical Connection



- | | |
|--------------------------------|--------------------------------|
| 1. 30-ampere Circuit Protector | 4. Wall Outlet: NEMA 6-30 R |
| 2. Measured Line Voltage | 5. Earth Ground |
| 3. North American Plug | 6. 30-ampere Circuit Protector |

To ensure safety, the instrument should be wired to a remote emergency switch (preferably outside the room where the ultracentrifuge is housed, or adjacent to the exit from that room). Refer to [Table A.1](#).

Table A.1 Required Wire Connections

| Wire Insulation Color | Terminal | Symbol | |
|-----------------------|--------------|------------|----------------|
| | | Harmonized | North American |
| Green/Yellow | Earth ground | | |
| Light Blue | Neutral | N | L |
| Brown | Live or Line | L | L |

Special Warranty for the Optima XPN

Special Warranty

Subject to the exceptions and upon the conditions specified below, Beckman Coulter, Inc., agrees to correct, either by repair, or, at its election, by replacement, any defects of material or workmanship which develop within one (1) year after delivery of the Optima Ultracentrifuge (the product), to the original Buyer by Beckman Coulter, or by an authorized representative, provided that investigation and factory inspection by Beckman Coulter discloses that such defect developed under normal and proper use.

Some components and accessories by their nature are not intended to and will not function for as long as one (1) year. If any such component or accessory fails to give reasonable service for a reasonable period of time, Beckman Coulter will repair or, at its election, replace such component or accessory. What constitutes either reasonable service and a reasonable period of time shall be determined solely by Beckman Coulter.

Replacement

Any product claimed to be defective must, if requested by Beckman Coulter be returned to the factory, transportation charges prepaid, and will be returned to Buyer with the transportation charges collect unless the product is found to be defective, in which case Beckman Coulter will pay all transportation charges.

Beckman Coulter makes no warranty concerning products or accessories not manufactured by it. In the event of failure of any such product or accessory, Beckman Coulter will give reasonable assistance to the Buyer in obtaining from the respective manufacturer whatever adjustment is reasonable in light of the manufacturer's own warranty.

Damage to the instrument while operating a rotor not of Beckman Coulter manufacture is not covered by warranty or service contract terms. Further, Beckman Coulter shall be released from all obligations under all warranties either expressed or implied, if the product covered hereby is repaired or modified by persons other than its own authorized service personnel, unless such repair is made by others who meet qualifications similar to those required of Beckman Coulter's service personnel, or unless such repair in the sole opinion of Beckman Coulter is minor, or unless such modification is merely the installation of a new Beckman Coulter plug-in component for such product.

Special Drive Warranty

During the instrument warranty period (one year), there will be no charge for drive replacement if the drive unit is installed, serviced, and operated in accordance with the conditions listed below. During the drive's second through tenth year of use there is a prorated drive replacement price based on years of use if the drive unit is installed, serviced, and operated in accordance with the conditions listed below.

Drive replacement price for units not under service contract = current drive exchange price
 $\times \left\langle \frac{\text{years of use}}{10} \right\rangle + \text{labor and travel.}$

NOTE For details of drive coverage with a service contract, contact your local Beckman Coulter service representative

Conditions

1. The drive has been operated only within its rated speed and temperature ranges.
2. The drive unit has not been subjected to unequal loading, improper rotor installation, corrosion from material spilled onto the hub or accumulated in the chamber of the instrument.
3. The drive unit has not been disassembled, modified, or repaired, except by Beckman Coulter personnel.
4. The drive unit was installed by a Beckman Coulter Field Service representative.
5. The instrument in which the drive unit has been used and operated, and its associated rotors, were manufactured by Beckman Coulter and serviced only by Beckman Coulter Field Service representatives.

If the above conditions are not met, the full appropriate exchange price for the drive will be charged.

Disclaimer

IT IS EXPRESSLY AGREED THAT THE ABOVE WARRANTY SHALL BE IN LIEU OF ALL WARRANTIES OF FITNESS AND OF THE WARRANTY OF MERCHANTABILITY AND THAT BECKMAN COULTER, INC. SHALL HAVE NO LIABILITY FOR SPECIAL OR CONSEQUENTIAL DAMAGES OF ANY KIND WHATSOEVER ARISING OUT OF THE MANUFACTURE, USE, SALE, HANDLING, REPAIR, MAINTENANCE, OR REPLACEMENT OF THE PRODUCT.

Overview

This section lists possible malfunctions and corrective actions. Maintenance procedures are described in [CHAPTER 9, Maintenance and Troubleshooting](#).

For any maintenance not covered in this manual, contact Beckman Coulter Field Service for assistance. USA customers can call 1-800-742-2345. For international contacts, see the website at www.beckman.com or use the contact numbers on the inside front cover of this book.

NOTE It is your responsibility to decontaminate the ultracentrifuge, as well as any rotors and/or accessories, before requesting service by Beckman Coulter Field Service.

Diagnostics/User Messages Chart

Refer to the chart below for a list of possible malfunctions and their corrective actions.

Table C.1 Diagnostics/User Messages Chart

| Message | Definition/Result | Recommended Action |
|--|--|---|
| D100 - Turn off power immediately | Instrument cannot trip breaker | Call Beckman Coulter Field Service. |
| D101 - SBC Communications | Single board computer boot error | Call Beckman Coulter Field Service. |
| D102 - SCB Communications | Communications error | Call Beckman Coulter Field Service. |
| D103 - Inverter Communications | Inverter I ² C error | Call Beckman Coulter Field Service. |
| D104 - Inverter Communications | Inverter ADC I ² C error - U21 | Call Beckman Coulter Field Service. |
| D105 - Inverter Communications | Inverter I ² C I/O Expander error | Call Beckman Coulter Field Service. |
| D107 - Inverter Communications | TEM ADC I ² C error - U24 | Call Beckman Coulter Field Service. |
| D108 - Network Path Access - Cannot reach configured network path | Network Path Access - Cannot reach configured network path | Check IP settings, network path, network credentials, and remote server connectivity. |

Table C.1 Diagnostics/User Messages Chart (Continued)

| Message | Definition/Result | Recommended Action |
|---|---|--|
| D109 - Network Communications | Network error - ethernet disconnected | Be sure network cable is plugged in. |
| D110 - Network Communications | Network error - cannot renew IP address | Check to see if network is active. |
| D111 - System Data Error | Data error | Note: If recovery fails, this condition will result in a 200 minute delay before the diagnostic can be cleared and the door opened. The power must be left on, until the delay period is completed. Call Beckman Coulter Field Service. |
| D112 - USB Port | USB import/export error | USB device may be full or removed too quickly. Save again with another USB device.. |
| D113 - Touch Screen Not Detected | Touch Screen USB cable not connected | Be sure USB touch screen cable is connected. If problem persists, call Beckman Coulter Field Service. |
| D114 - Code error | Bad checksum on code flash | Call Beckman Coulter Field Service. |
| D115 - Code error | Corrupted data flash | Note: This condition will result in a 200 minute delay before the diagnostic can be cleared and the door opened. The power must be left on, until the delay period is completed. Call Beckman Coulter Field Service. |
| A117 - Alert: Printer error | No printer or printer driver | Be sure printer is turned on and drivers are installed. If problem persists, call Beckman Coulter Field Service. |
| A118 - Alert: Hard drive error | Enhanced Write Filter disabled | Call Beckman Coulter Field Service. |
| A120 - Alert: Simulator | Simulator not found | Call Beckman Coulter Field Service. |
| D119 - SBC Communication | Unable to open serial port | Call Beckman Coulter Field Service. |
| D121 - Internal software error | Software error | Call Beckman Coulter Field Service. |
| A122 - Alert: Firmware error | Firmware error caused reset | Call Beckman Coulter Field Service. |
| D123 - UI Communications | Communications error | Call Beckman Coulter Field Service. |

Table C.1 Diagnostics/User Messages Chart (*Continued*)

| Message | Definition/Result | Recommended Action |
|---|---|---|
| A124 - Alert: Hard drive space low | Hard drive is 90% full | Backup files soon. Call Beckman Coulter Field Service. |
| D125 - SBC Communications | Communications parameters are not compatible | Call Beckman Coulter Field Service. |
| A126 - Zonal or Continuous Flow Run Auto-Restarted | Recoverable Diagnostic that occurred during Zonal (or Continuous Flow) run has gone passive and run has resumed. | Review Diagnostic Log for source of run disruption. Note timing of diagnostics and extend run time as required. |
| A127 - Zonal or Continuous Flow Run Manually Restarted | Recoverable Diagnostic that occurred during a Zonal (or Continuous Flow) run has gone passive and user has resumed the run. | Review Diagnostic Log for source of run disruption. Note timing of diagnostics and extend run time as required. |
| A128 - Zonal or Continuous Flow Run Abandoned | Recoverable Diagnostic stayed Active and has caused Zonal (or Continuous Flow) run to Stop. | Review Diagnostic Log for source of run disruption. |
| A200 - Alert: AC Power Loss - Run continued | AC Power Loss - Run continued | None |
| A201 - Alert: AC Power Loss - Run stopped | AC Power Loss - Run, Delayed Run, or Program stopped | None |
| D202 - Bus Current | Bus current measures zero (<0.1A) | Call Beckman Coulter Field Service. |
| D203 - Bus Voltage^a | Bus voltage too high (>220VDC) or Bus voltage too low (<180VDC) | Call Beckman Coulter Field Service. |
| D204 - Power Supply^a | Inverter +18V supply too high (>19.8VDC) | Call Beckman Coulter Field Service. |
| D205 - Power Supply^a | Inverter +18V supply too low (<16.2VDC) | Call Beckman Coulter Field Service. |
| D206 - Power Supply^a | Inverter +5V supply too high (>5.5VDC) | Call Beckman Coulter Field Service. |
| D207 - Power Supply^a | Inverter +5V supply too low (<4.5VDC) | Call Beckman Coulter Field Service. |

Table C.1 Diagnostics/User Messages Chart (Continued)

| Message | Definition/Result | Recommended Action |
|---|---|--|
| D208 - Power Supply^a | Inverter -5V supply too high (>-4.5VDC) | Call Beckman Coulter Field Service. |
| D209 - Power Supply^a | Inverter -5V supply too low (<-5.5VDC) | Call Beckman Coulter Field Service. |
| D210 - Power Supply | SCB +12V supply too high (>13.2VDC) or SCB +12V supply too low (<10.8VDC) | Call Beckman Coulter Field Service. |
| D211 - Power Supply^a | SCB +3.3V supply too high (>3.63VDC) | Call Beckman Coulter Field Service. |
| D212 - Power Supply^a | SCB analog +3.3V supply too high (>3.63VDC) or SCB analog +3.3V supply too low (<2.97VDC) | Call Beckman Coulter Field Service. |
| D213 - Power Supply^a | System +24V supply too high (>26.4VDC) or System +24V supply too low (<21.6VDC) | Call Beckman Coulter Field Service. |
| D214 - Power Supply^a | System +5V supply too high (>5.5VDC) | Call Beckman Coulter Field Service. |
| D216 - AC Power Out of Range | AC Power Out of Range | Check electrical power source. |
| A217 - Alert: AC Power Voltage Sag^a | AC voltage sagged below 180Vac or AC voltage/frequency is out of range during braking. Power cycled too quickly. | Wait 1 minute before turning the instrument back on. |
| D300 - Rotor Speed | Rotor speed exceeds maximum rated speed | Call Beckman Coulter Field Service. |
| A301 - Alert: Rotor Speed Adjusted | Rotor set speed adjusted | None |
| A302 - Alert: Inertia Calibration | Inertia calibration failure | Call Beckman Coulter Field Service. |
| D303 - Speed Signals | Overspeed timing signal is <9 counts/revolution or >47 counts/revolution, or overspeed timing signal is unstable | <ol style="list-style-type: none"> 1. Check the condition of the rotor overspeed disk. 2. Make sure the rotor is installed properly. 3. Verify the rotor load is within limits specified in the rotor manual. |

Table C.1 Diagnostics/User Messages Chart (*Continued*)

| Message | Definition/Result | Recommended Action |
|---|---|---|
| D304 - Speed Signals | No tachometer signal | <p>NOTE This condition will result in a 200-minute delay before the diagnostic can be cleared and the door opened. The power must be left on, until the delay period is completed.</p> <ol style="list-style-type: none"> 1. Make sure the rotor is installed properly. 2. Check the condition of the rotor overspeed disk. 3. Verify the rotor load is within limits specified in the rotor manual. 4. If the problem persists, call Beckman Coulter Field Service. |
| D305 - Inertia^a | Inertia check failure | Be sure rotor is loaded properly. |
| A400 - Alert: Vacuum Calibration | Vacuum calibration failure | Call Beckman Coulter Field Service. |
| A401 - Alert: Slow Vacuum | Vacuum exceeds 750 microns after 4 minutes | <ol style="list-style-type: none"> 1. Make sure door o-ring is clean, undamaged, and properly lubricated. 2. Check for sample leakage. Clean and dry the rotor chamber if needed. 3. If the problem persists, call Beckman Coulter Field Service. |
| D402 - Slow Vacuum^b | Vacuum not <20 microns after 20 minutes | <ol style="list-style-type: none"> 1. Make sure door o-ring is clean, undamaged, and properly lubricated. 2. Check for sample leakage. Clean and dry the rotor chamber if needed. 3. If the problem persists, call Beckman Coulter Field Service. |
| D403 - Lost Vacuum^b | Vacuum >750 microns for 1 minute after being <750 microns | <ol style="list-style-type: none"> 1. Make sure door o-ring is clean, undamaged, and properly lubricated. 2. Check for sample leakage. Clean and dry the rotor chamber if needed. 3. If the problem persists, call Beckman Coulter Field Service. |
| D404 - Lost Vacuum^b | Vacuum >50 microns for 10 minutes after being <20 microns | <ol style="list-style-type: none"> 1. Make sure door o-ring is clean, undamaged, and properly lubricated. 2. Check for sample leakage. Clean and dry the rotor chamber if needed. 3. If the problem persists, call Beckman Coulter Field Service. |
| D407 - Vacuum Vent | Vacuum vent solenoid not connected | Call Beckman Coulter Field Service. |

Table C.1 Diagnostics/User Messages Chart (Continued)

| Message | Definition/Result | Recommended Action |
|---|--|---|
| D408 - Vacuum Vent | Vacuum vent can not be opened | Call Beckman Coulter Field Service. |
| D500 - Temperature Control | Ambient thermistor open | Call Beckman Coulter Field Service. |
| D501 - Temperature Control | Ambient thermistor shorted | Call Beckman Coulter Field Service. |
| D502 - Temperature Control | Ambient temperature out of range (<10°C or >35°C) | Adjust room temperature before operating. |
| D503 - Temperature Control^c | Can thermistor not connected | Call Beckman Coulter Field Service. |
| D504 - Temperature Control^b | Can thermistor shorted | Call Beckman Coulter Field Service. |
| D505 - Temperature Control | Can temperature out of limits (<-30°C or >70°C) | Call Beckman Coulter Field Service. |
| D506 - Temperature Control^d | TEM voltage too high | Call Beckman Coulter Field Service. |
| D507 - Temperature Control^d | TEM voltage too low | Call Beckman Coulter Field Service. |
| D508 - Temperature Control^d | TEM impedance too low | Call Beckman Coulter Field Service. |
| D509 - Temperature Control^d | TEM impedance too high | Call Beckman Coulter Field Service. |
| D510 - Temperature Control^c | Rotor temperature error rate of change is not decreasing and rotor temperature is greater than 10°C from set temperature after running for 15 minutes. | Call Beckman Coulter Field Service. |
| D512 - Temperature Communications | D512 - Temperature Communications | Call Beckman Coulter Field Service. |
| D513 - Temperature Communications | No communications - TEM I ² C | Call Beckman Coulter Field Service. |
| D514 - Temperature Communications | No communications - thermopile | Call Beckman Coulter Field Service. |
| D600 - Drive fault^a | Drive fault | Call Beckman Coulter Field Service. |

Table C.1 Diagnostics/User Messages Chart (*Continued*)

| Message | Definition/Result | Recommended Action |
|---|----------------------------------|---|
| D601 - Drive | Bus current too high (>30A) | Call Beckman Coulter Field Service. |
| D602 - Drive Temperature^a | Drive temperature >69°C | Call Beckman Coulter Field Service. |
| D603 - Damper | Damper coil status error | Call Beckman Coulter Field Service. |
| D604 - CF-32 Rotor Oil Level | CF-32 oil level error | Make sure the rotor oil level switch is installed on the back panel for CF-32 operation. Add oil to CF-32 rotor. |
| D605 - Drive Performance^e | Abnormal rate of change in speed | Call Beckman Coulter Field Service. |
| D606 - Drive Performance | Abnormal tachometer frequency | <p>NOTE This condition will result in a 200-minute delay before the diagnostic can be cleared and the door opened. The power must be left on, until the delay period is completed.</p> <ol style="list-style-type: none"> 1. Make sure the rotor is installed properly. 2. Check the condition of the rotor overspeed disk. 3. Verify the rotor load is within limits specified in the rotor manual. 4. If the problem persists, call Beckman Coulter Field Service. |
| D607 - Drive Performance | Drive frequency error | Call Beckman Coulter Field Service. |
| D608 - Drive Performance | Tachometer frequency >103K rpm | Call Beckman Coulter Field Service. |
| A700 - Alert: Imbalance^e | Imbalance detector error | <ol style="list-style-type: none"> 1. Make sure the rotor is installed properly. 2. Verify the rotor load is within limits specified in the rotor manual. 3. If the problem persists, call Beckman Coulter Field Service. |
| A800 - Alert: Door Latch^c | Door latch will not engage | <ol style="list-style-type: none"> 1. Make sure the door is closed before selecting Start. 2. If the problem persists, call Beckman Coulter Field Service. |

Table C.1 Diagnostics/User Messages Chart (*Continued*)

| Message | Definition/Result | Recommended Action |
|---|-------------------------------|-------------------------------------|
| A802 - Alert: Door Latch^c | Door latch changed states | Call Beckman Coulter Field Service. |
| D803 - Door Latch | Door latch will not disengage | Call Beckman Coulter Field Service. |

- a. In normal operation, this diagnostic event will stop the run. However in zonal and continuous flow operation, when the error occurs, the rotor will begin to stop. If the error condition goes away, the instrument will automatically continue the run at previous run speed. When the run is automatically continued, an A126 Alert will be recorded. If the run is stopped because the error condition did not go away, an A128 Alert will be recorded.
- b. In normal operation, this diagnostic event will stop the run. However, in zonal and continuous flow operation, this diagnostic event will continue the run, which may result in elevated sample temperature. It is the responsibility of the operator to monitor the temperature and take any appropriate action, such as unloading the sample.
- c. In normal operation, this diagnostic event will stop the run. However in zonal and continuous flow operation, when this error occurs, the instrument will maintain the load/unload speed (depending on process phase). If the error condition goes away, the operator can continue the run. When the run is continued, an A127 Alert will be recorded. If the error condition does not go away, the operator should recover the sample if possible and manually stop the run by pressing the stop button.
- d. In normal operation, this diagnostic event will stop the run. However in zonal and continuous flow operation, when this error occurs, the instrument will maintain the load/unload speed (depending on process phase). The operator should recover the sample if possible and manually stop the run by pressing the stop button.
- e. In normal operation, this diagnostic event will stop the run. However in zonal and continuous flow operation, when the error occurs, the rotor will begin to stop. If the error condition goes away, the instrument will go to and maintain the load/unload speed (depending on process phase). The operator can then restart the run or unload the rotor. When the run is continued, an A127 Alert will be recorded. If the run is stopped because the error condition did not go away, an A128 Alert will be recorded.

www.beckman.com

